

# tineco

## iFLOOR Y2 SERIES

Cordless Floor Washer

Bedienungsanleitung

Instruction Manual

Manual De Uso

Mode D'emploi

Manuale D'istruzioni

Handleiding

Instrukcja obsługi

Kullanım Kılavuzu

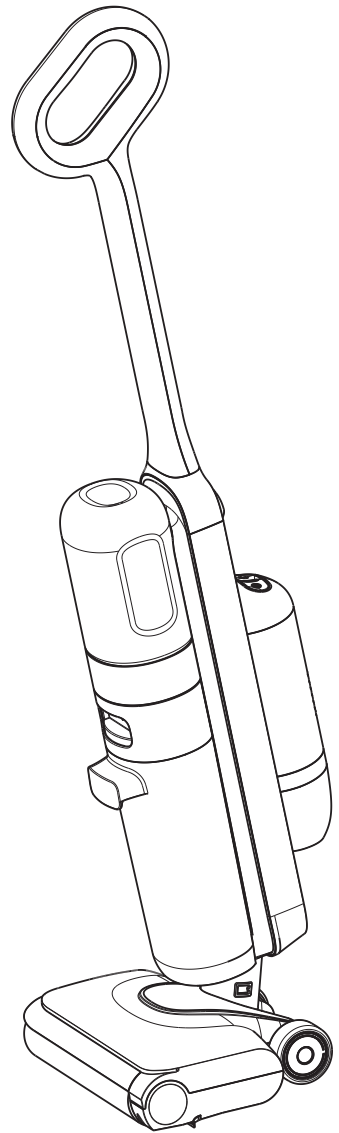

\*Actual product may differ from illustration.

**TINECO IS HERE TO HELP.**

We'll get back to you within 24 hours.



[www.tineco.com](http://www.tineco.com)

# CONTENTS

Important Safety Instructions.....	20
Specifications.....	24
Overview.....	25
Accessories.....	26
Assembly.....	27
Operation.....	28
Maintenance.....	31
Troubleshooting.....	34
Warranty.....	35



**MORE LANGUAGES**

ARE AVAILABLE ON OUR OFFICIAL WEBSITE



**TINECO IS HERE TO HELP.**

We'll get back to you within 24 hours.



[www.tineco.com](http://www.tineco.com)

# Important Safety Instructions

## SAVE THESE INSTRUCTIONS

### Household use only.

When using an electrical appliance, basic precautions should always be followed, including the following:

READ ALL INSTRUCTIONS BEFORE USING (THIS APPLIANCE). Failure to follow the warnings and instructions may result in electric shock, fire and/or serious injury.

### WARNING – To reduce the risk of fire, electric shock, or injury:

1. This appliance can be used by children aged from 8 years and above and persons with reduced physical, sensory or mental capabilities or lack of experience and knowledge if they have been given supervision or instruction concerning use of the appliance in a safe way and understand the hazards involved. Children should not play with the appliance. Cleaning and user maintenance shall not be performed by children without supervision.
2. The appliance is not to be used by persons (including children) with reduced physical, sensory or mental capabilities, or lack of experience and knowledge, unless they have been given supervision or instruction.
3. Use only indoors, on non-carpeted floor surfaces such as vinyl, tile, sealed wood, etc. Be careful not to run over loose objects or edges of area rugs. Stalling the brush may result in premature belt failure.
4. Do not allow to be used as a toy. Close attention is necessary when used by or near children, pets or plants.
5. Use only as described in this manual. Use only manufacturer's recommended attachments.
6. Do not use with a damaged cord or plug. If appliance has been dropped, damaged, left outdoors, dropped into water, or is not working as it should, return it to a service center.
7. Do not handle charger, including charger plug, and charger terminals with wet hands.
8. Do not put any object into openings. Do not use with any opening blocked; keep free of dust, lint, hair, and anything that may reduce air flow.
9. Keep hair, loose clothing, fingers, and all parts of your body away from openings and moving parts.
10. Use extra care when cleaning on stairs.
11. Do not use to pick up flammable or combustible liquids, such as gasoline, or use in areas where they may be present.
12. Do not pick up anything that is burning or smoking, such as cigarettes, matches, or hot ashes.
13. Do not use without filter.
14. Prevent unintentional activation. Ensure the switch is in the off-position before picking up or carrying the appliance. Carrying the appliance with your finger on the switch or energizing appliance that have the switch on invites accidents.
15. Always switch off the appliance before making any adjustments, changing accessories, or storing the appliance. Such preventive safety measures reduce the risk of starting the appliance accidentally.

16. Recharge only with the charger specified by Tineco. A charger that is suitable for one type of battery pack may create a risk of fire when used with another battery pack.
17. Under abusive conditions, liquid may be ejected from the battery; avoid contact. If contact accidentally occurs, flush with water. If liquid comes into eye contact, seek medical help. Liquid ejected from the battery may cause irritation or burns.
18. Do not use a battery pack or appliance that is damaged or modified. Damaged or modified batteries may exhibit unpredictable behavior resulting in fire, explosion or risk of injury.
19. Do not expose a battery pack or appliance to fire or excessive temperature. Exposure to fire or temperature above 266°F (130°C) may cause an explosion.
20. Follow all charging instructions and do not charge the battery pack or appliance outside of the temperature range specified in the instructions. Charging improperly or at temperatures outside of the specified range may damage the battery and increase the risk of fire.
21. Have servicing performed by a qualified repair person using only identical replacement parts. This will ensure that the safety of the product is maintained.
22. This appliance contains battery cells that are non-replaceable. Do not modify or attempt to repair the appliance or the battery pack except as indicated in the instructions for use and care.
23. Always turn off this appliance before connecting or disconnecting the motorized nozzle.
24. Do not charge or store the appliance outdoors or inside the car. Only charge, store or use the battery in a dry indoor area where the temperature is higher than 39.2°F (4°C) but lower than 104°F (40°C). The charger is for indoor use only.
25. Do not use to pick up ultrafine particles, such as lime, cement, sawdust, gypsum powder, or ashes.
26. Do not use to pick up sharp objects, such as metallic nails, pieces of glass, metal paper clips, or pins.
27. Do not use to pick up hazardous material and chemicals, such as solvent, drain cleaner, strong acids, or strong alkali.
28. Stop using immediately if the appliance is overheating, making unusual noises, producing unusual odors, performing low suction, or leaks electricity.
29. Turn cleaner OFF and disconnect from electrical outlet for long-term storage.
30. Always clean the Dirty Water Tank after each use to avoid potential blockage, which may lead to low suction power, motor overheating, or reduce the service life of the appliance.
31. Store appropriately indoors in a dry place after use.
32. Do not place or submerge appliance in standing water or try to clean flooded areas.
33. All data and technical instructions of this manual are based on results from lab tests of Tineco or designated third parties. The company reserves all rights for final explanations.
34. The plug must be removed from the socket-outlet before cleaning or maintaining the appliance.
35. A hazard may occur if the appliance runs over the supply cord.
36. Do not use the appliance when the water depth is more than 5mm above the surface.
37. Do not pull or carry by cord, use cord as a handle, close a door on cord, or pull cord around sharp edges or corners. Do not run appliance over cord. Keep cord away from heated surfaces.
38. Do not unplug by pulling on cord. To unplug, grasp the plug, not the cord.

## Range of Usage

1. The cordless hard floor cleaner is to be used on indoor hard floors, such as vinyl, tile, sealed wood, etc. Use on a rough surface may not get the best performance.
2. Keep your appliance away from heat sources, such as fireplace or heater, to avoid casing deformation.
3. Do not use to pick up flammable or combustible liquids, ultrafine particles, sharp objects, hazardous material, chemicals or anything that is burning or smoking, as described above.

## About Cleaning Solution

1. A large amount of cleaning solution entering into the motor may cause damage to the appliance.
2. Add solution as instructed in the Operation section. We recommend using the provided cleaning solution. Do not use the product with acidic, alkaline solution, or any substances harmful to the environment.
3. Keep out of reach of children. If any solution gets into the eyes, immediately flush them with clean water. If any solution is swallowed by accident, seek medical care immediately.
4. Dirty water and solution disposal should comply with local environmental regulations.

## About the Appliance

1. Do not modify or attempt to repair the appliance except as indicated in the instructions for operating and cleaning.
2. Charge the appliance with the Tineco adaptor. Input Voltage: AC 100-240V. Both high and low voltages can damage the adaptor, appliance, or even cause danger to the user.
3. Use extra care when cleaning on stairs.
4. Ensure that the Power Switch is in the OFF-position before picking up or carrying the appliance. Do not lay flat or lean the appliance so as to prevent dirty water from entering into the motor.
5. To avoid being tripped accidentally, please put away the appliance on the charging dock.
6. Always install the Dirty Water Tank and Clean Water Tank properly before use.
7. Do not allow the appliance or charger to get wet to avoid risk of fire or injury caused by a short circuit.

## Recycling Instructions according to Battery Law



The rechargeable battery contains materials that are harmful to the environment and must therefore be removed from the device before disposal. The device must be switched off to remove the rechargeable battery.

Batteries and rechargeable batteries must not be disposed of in household waste! Every consumer is obliged to hand in all batteries and rechargeable batteries, regardless of whether they contain harmful substances or not, at a collection point in his or her municipality/district or at a retailer, so that they can be disposed of in an environmentally friendly manner. Batteries and rechargeable batteries should only be returned when discharged.

Batteries and rechargeable batteries are therefore marked with the symbol left.

## Recycling Instructions according to WEEE



Waste electrical and electronic equipment must not be disposed of with household waste! Every consumer is obliged to hand in all appliances at the end of their service life at a collection point in his or her municipality/district or at a retailer so that they can be disposed of properly and in an environmentally friendly manner.

The illustration left shows the wheeled bin symbol indicating separate collection of waste electrical and electronic equipment (WEEE).

## For EU Countries:

Hereby declare that this product complies with the essential requirements of all relevant directives and regulations applicable in the European Community. The Declaration of Conformity (DoC) can be obtained from our website.

Visit <https://global.tineco.com/compliance/>

Your declaration will be downloaded as a PDF file.

## Symbols:

	Read the instruction manual
	Class II
	Short-circuit-proof safety isolating transformer
	Switch mode power supply
	For indoor use only
	Direct current
	Alternating current

# Specifications

EN

Product	iFLOOR Y2 SERIES
AC Input	100-240V~
Voltage	25.2V $\approx$ 2500mAh Li-ion
Rated Power	140W
Running Time	~30 mins
Charging Time	5 hrs
Water Flow Rate	15-100 ml/min
CWT Capacity	1.0L
DWT Capacity	0.8L
Waterproof	IPX4

# Overview

**Note:**

Please refer to the purchase link for the actual accessories and product features.

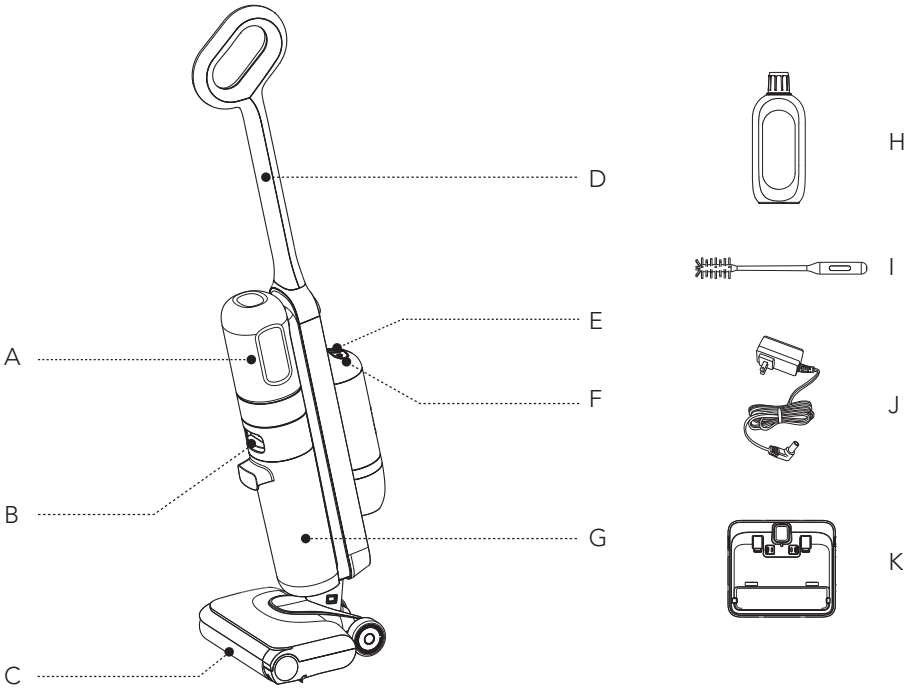

- A. Clean Water Tank (CWT)
- B. Dirty Water Tank Release
- C. Brush Roller
- D. Tube
- E. Self-cleaning Button
- F. Power On/Off Button

- G. Dirty Water Tank (DWT)
- H. Deodorizing & Cleaning Solution
- I. Cleaning Tool
- J. Adaptor
- K. Charging Dock

# Accessories

## Note:

Accessories may vary among markets. If you require more accessories, please go to [www.tineco.com](http://www.tineco.com) or [store.tineco.com](http://store.tineco.com).

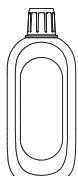

## Deodorizing & Cleaning Solution

Removes dirt, grime, grease and tough stains from most types of hard surfaces, like tile, marble, sealed hardwood floors, and more. Always use Tineco solution in your appliance. Add one bottle cap of solution to each full tank of clean water.



## Brush Roller

Soft roller head with bristles can be used to vacuum and wash at the same time. It can be easily cleaned with the self-cleaning function.

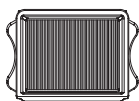

## Dry Filter

Dry filter and filter net can block large particles and debris, ensuring the appliance's durability.

- \* Please install the dry filter before use, or it may lead to weak suction.
- \* Replace every 6 months.



## Cleaning Tool

A full brush to clean the DWT, brush chamber and opening. The tool also has a bristled end to remove dirt and mud on the roller and DWT.

# Assembly

## How to Assemble/Disassemble

### Note:

For water tank and brush assembly, please refer to "Operation" and "Maintenance".

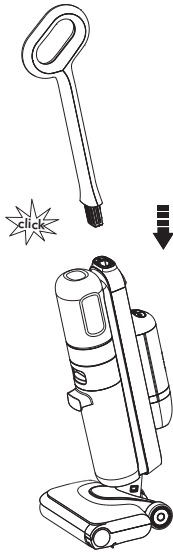

To assemble the handle, insert it into the appliance until you hear a click.

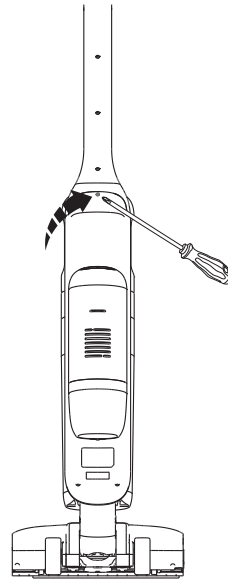

In the event that the handle needs to be disassembled, press the spring to release the handle with a tool (like a screwdriver) and lift the released handle from the appliance.

# Operation

## Preparing for Use

Before first use, please charge the appliance for approximately 5 hours (refer to "Charging Instructions" for details).

\* Based on results from Tineco Laboratory tests. Lab temperature 39.2°F (4°C) ~ 104°F (40°C).

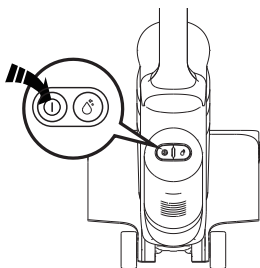

Press the ⏻ button and the appliance will start in default mode. Press it again to turn off the appliance.

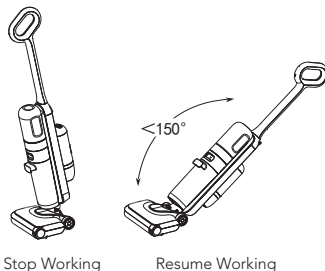

The appliance will stop working when put uprightly and start running again when reclined.  
\* Do not recline more than 150° to avoid water leakage.

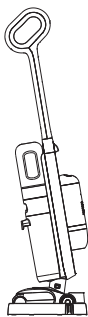

Place the appliance on the charging dock vertically after use for charge and storage.

### Note:

- Do not vacuum foamed liquid.
- To vacuum water left on the surface, the appliance will switch off in 3 seconds after powering off.

## Filling Clean Water Tank

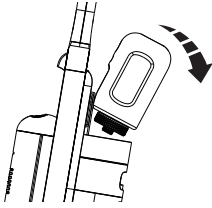

Hold the water tank and lift it upwards with force to remove the water tank.

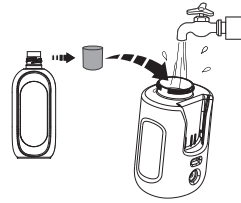

Open the tank cap, and fill with tap water. When deep cleaning is necessary, add one bottle cap of solution to the CWT and tightly close the cap.

### Note:

**Only use water under 140°F/60°C.**

**DO NOT USE HOT WATER.**

**Only Tineco solution is recommended.**

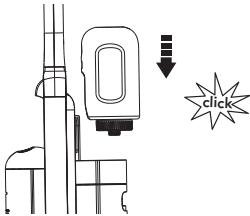

Hold the water tank and align the groove at the back of the tank with the corresponding slot on the machine body. Press down firmly to complete the installation.

## Charging Instructions

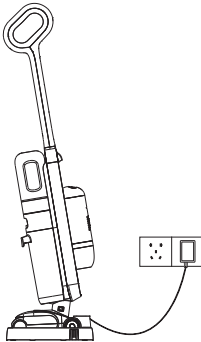

Charging preparation: Plug adaptor to power outlet.

Connect external charging cord to charge.

To charge, place appliance on charging dock.

1. To charge the appliance, connect the external charging cord to the charging dock and plug it into the wall outlet.
2. To avoid tripping hazards, please place the appliance on the charging dock near a wall during charging.

### Warning:

- Only charge the appliance with the adaptor supplied by Tineco.
- During long periods of non-use, the appliance must be charged once every 3 months for optimal performance. It may take approximately 5 hours for a full charge.
- Store indoors in a dry place. Do not expose the appliance to sunlight or freezing temperatures. Recommended temperature range: 39.2°F (4°C) ~ 104°F (40°C).

## Runtime

- The runtime is approximately 30 minutes.
- Estimated runtime data was obtained by Tineco Laboratory.

## Charging Time

- A full charge takes approximately 5 hours.
- Estimated data was obtained by Tineco Laboratory using ambient temperatures between 39.2°F (4°C) to 104°F (40°C).

## Indicator (Applicable for specific model)

### When in Use



Flashing red: low power.



Solid blue: regular mode.



Off: no power or battery malfunction.



Solid red: brush roller has a blockage or DWT is full.

### During Charging



Flashing blue: charging.

### Fully Charged



Within 5 minutes of full charge: solid blue.



After 5 minutes: light off.

# Maintenance

## Note:

- For optimal performance and to prevent odors, always **clean** and **dry** DWT, floater, filters, brush roller **completely** after each use.
- Please make sure each part is installed correctly or the appliance may not work properly.
- After maintenance, place the appliance on the storage tray vertically. Do not expose the appliance to direct sunlight, and store it indoors in a dry place.

## Main Body

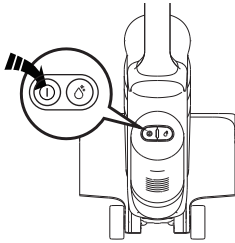

To reduce the risk of injury, switch off before performing maintenance.



Use a cloth to clean the surface with a neutral detergent. The cloth should be dry to prevent water from entering the appliance.

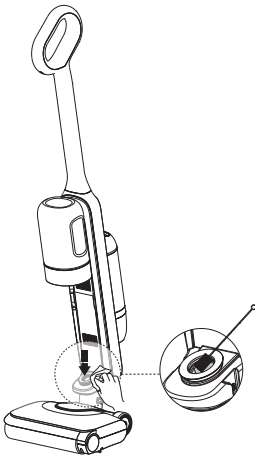

Remove Dirty Water Tank, clean the dirt water port with a damp cloth or the cleaning tool to prevent blockage.

## Dirty Water Tank

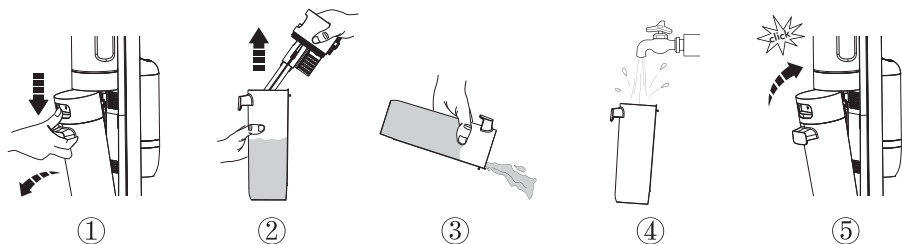

- When dirty water reaches the Max line, the floater will block off the DWT and create a high pitched sound indicating it's time to switch off the appliance.
- Pull up the tank lid to empty the DWT. Use the cleaning tool to remove remaining debris. Rinse the inside of the DWT and place back into the appliance.

## Dry Filter & Floater

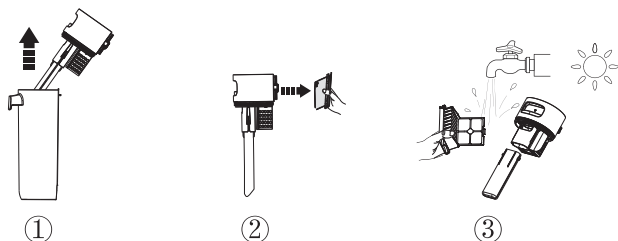

- Grasp recessed area on each side of the dry filter and pull out. Then pull out the floater. Rinse under running water and must be completely dry before recombining with the lid of the DWT.

## Brush Roller Self-cleaning

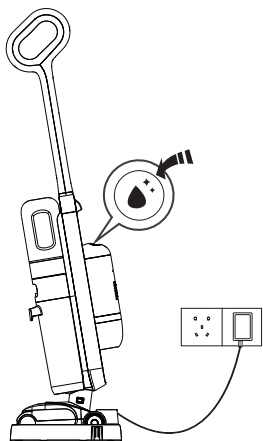

1. Place the appliance on the charging dock after use, and then press the self-cleaning button to begin the progress.
2. Once complete, the appliance will begin charging.

### Note:

- Ensure the appliance is plugged in and the battery has enough power.
- Before self-cleaning cycle, please clean the DWT and ensure the water level in the CWT > 40%.

## Brush Roller

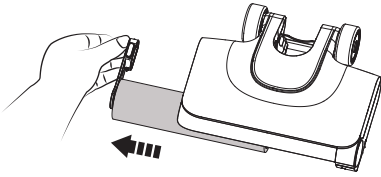

Press and hold the side buckle of the brush roller with your fingers, then lift the handle on the left end to remove the brush roller.

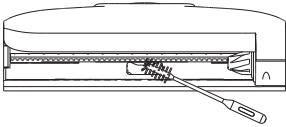

Remove hair and debris from the brush roller chamber and the opening with the cleaning tool.

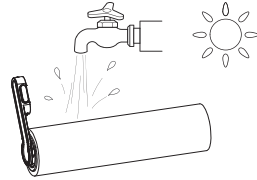

Rinse the brush roller with clean water and remove tangled hair or debris by hand. Thoroughly air dry before putting it back in place.

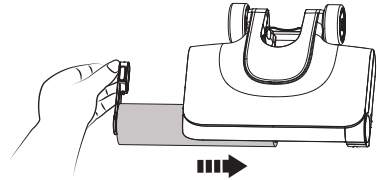

Install the brush roller by inserting its end into the right side of the holder, then lock the pull tab into place.

# Troubleshooting

EN

Problem	Possible cause	Solution
The appliance does not turn on	Auto protection for overheating	Restart after cooling down
	The dirty water in DWT has reached the MAX line	Empty the dirty water and then reinstall the DWT
Weak suction	The dry filter is not installed, or the dry filter is dirty	Install the dry filter or clean and allow it to dry completely
Appliance won't charge	Incompatible adaptor	Use the original adaptor
	The adaptor is not correctly inserted	Reinsert the adaptor correctly
The indicator turns red	The brush roller is blocked	Remove blockages
	The dirty water in DWT has reached the MAX line	Empty the dirty water and then reinstall the DWT
The indicator blinks red	Battery low	Charge the appliance, or restart
Indicator off in operation	Battery overheats or malfunctions	Cool the appliance down and restart

## Note:

If the above troubleshooting guide fails to provide a solution, please visit our website [www.tineco.com](http://www.tineco.com) for further support.

# Warranty

## 2-YEAR LIMITED WARRANTY

- Only applies to purchases made from authorized retailers of Tineco.
- Is subject to the adherence of the requirements outlined in this instruction manual, and is subject to further conditions outlined below.
- This warranty is governed by and construed under the laws of the country in which the purchase took place. We provide 2-year warranty or a warranty period as stipulated by applicable local law, whichever is longer.

## WHAT IS COVERED?

- Your Tineco appliance has a 2-year warranty against original defects in material and workmanship, when used for private household purposes in accordance with the Tineco Instruction Manual. Motorized accessories and battery bought separately come with a 1-year warranty.
- This warranty provides, at no extra cost to you, all labor and parts necessary to ensure your appliance is in proper operating condition during the warranty period.
- This warranty will only be valid if the appliance is used in the country in which it was sold.

## WHAT IS NOT COVERED?

Tineco shall not be liable for costs, damages or repairs incurred as a result of:

- Appliances purchased from an unauthorized dealer.
- Careless operation or handling, misuse, abuse and/or lack of maintenance or use not in accordance with the Tineco Instruction Manual.
- Use of the appliance other than for normal domestic purposes, e.g. for commercial or rental purposes.
- Use of parts not in accordance with the Tineco Instruction Manual.
- Use of parts and accessories other than those produced or recommended by Tineco.
- External factors unrelated to product quality and use, such as weather, modifications, accidents, electrical outages, power surges or acts of God.
- Repairs or alterations carried out by unauthorized parties or agents.
- Failing to clear blockage and other hazardous material from the appliance.
- Normal wear and tear, including normal wearing parts, such as clear bin, belt, filter, HEPA, brush bar, and power cord (or where external damage or abuse is diagnosed), carpet or floor damage due to use not in accordance with manufacturer's instructions or failure to turn the brush bar off when necessary.
- Reduction in battery discharge time due to battery age or use.

## WARRANTY LIMITATIONS

- Any implied warranties relating to your appliance including but not limited to warranty of merchantability or warranty of fitness for a particular purpose, are limited to the duration of this warranty.
- Warranty coverage applies to the original owner and to the original battery only and is not transferable.
- This limited warranty gives you specific legal rights. You may also have other rights which vary by region.
- Manufacturer's warranties may not apply in all cases, depending on factors such as use of the product, where the product was purchased, or who you purchased the product from. Please review the warranty carefully, and contact the manufacturer if you have any questions.

## WARRANTY SERVICE

**Register:** We highly recommend that upon purchase, you register your appliance by logging into our official website ([www.tineco.com](http://www.tineco.com)) or scanning the QR code (see right) to enjoy more exclusive benefits. To register, please enter the whole serial number (on the back of the appliance). Failure to register your product won't diminish your warranty rights.

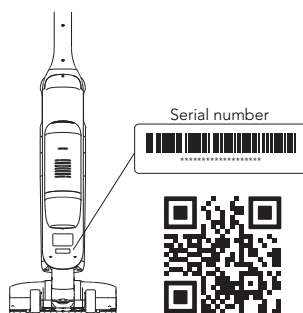

**How to Claim:** Please retain your proof of purchase. To make a claim under our Limited Warranty, you need to provide your serial number and the original purchase receipt with the purchase date and order number on it.

All work will be carried out by Tineco or its authorized agency.

Any replaced defective parts will become the property of Tineco.

Service under this warranty will not extend the period of this warranty.

Visit Tineco website [www.tineco.com](http://www.tineco.com)  
for expert customer service.

tineco  
Live Easy.  
Enjoy Life.

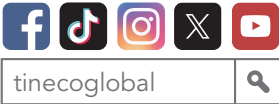

 [www.tineco.com](http://www.tineco.com)

Kontaktieren Sie uns. Wir melden uns innerhalb 24 Stunden bei Ihnen.

Contact us - We'll get back to you within 24 hours.

Conéctese con nosotros. Nos pondremos en contacto con usted dentro de 24 horas.

Contactez-nous. Nous vous répondrons dans les 24 heures.

Contattarci - risponderemo entro 24 ore.

Neem contact met ons op - we nemen binnen 24 uur contact met u op.

Skontaktuj się z nami – odpowiemy w ciągu 24 godziny.

Bize ulaşın - 24 saat içinde size geri döneceğiz.

