



DEEBOT **X2** OMNI

Instruction Manual

Instruction Manual	EN	 P03
Bedienungsanleitung	DE	 P38
Manuel d'instructions	FR	 P74
Manuale d'istruzioni	IT	 P110
Bruksanvisning	SE	 P145
Bruksanvisning	NO	 P180
Brugsanvisning	DK	 P215
Käyttöopas	FI	 P250
Kullanım Kılavuzu	TR	 P285

For the Instruction Manual in further languages, visit: <https://www.ecovacs.com>.

Die Bedienungsanleitung in anderen Sprachen findest du unter: <https://www.ecovacs.com>.

Pour obtenir le Manuel d'instruction dans différentes langues, visitez : <https://www.ecovacs.com>.

Per il manuale d'istruzioni in altre lingue, visitare il sito Web: <https://www.ecovacs.com>.

Bruksanvisningen finns på fler språk på: <https://www.ecovacs.com>.

Du finner bruksanvisningen på flere språk på: <https://www.ecovacs.com>.

Du kan finde brugsanvisningen på flere sprog på: <https://www.ecovacs.com>.

Käyttöopas on saatavilla muilla kielillä osoitteessa <https://www.ecovacs.com>.

Diğer dillerde sunulan Kullanım Kılavuzu için şu adresi ziyaret edin: <https://www.ecovacs.com>.

Important Safety Instructions

IMPORTANT SAFETY INSTRUCTIONS

When using an electrical Appliance, basic precautions should always be followed, including the following:

READ ALL INSTRUCTIONS BEFORE USING THIS APPLIANCE

SAVE THESE INSTRUCTIONS

1. This Appliance can be used by children aged from 8 years and above and persons with reduced physical, sensory or mental capabilities or lack of experience and knowledge if they have been given supervision or instruction concerning use of the Appliance in a safe way and understand the hazards involved. Children shall not play with the Appliance. Cleaning and user maintenance shall not be made by children without supervision.
2. Clear the area to be cleaned. Remove power cords and small objects from the floor that could entangle the Appliance. Tuck rug fringe under the rug base, and lift items such as curtains and tablecloths off the floor.
3. If there is a drop off in the cleaning area due to a step or stairs, you should operate the Appliance to ensure that it can detect the step without falling over the edge. It may become necessary to place a physical barrier at the edge to keep the unit from falling. Make sure the physical barrier is not a trip hazard.
4. Only use as described in this manual. Only use attachments recommended or sold by the manufacturer.
5. Please make sure your power supply source voltage matches the power voltage marked on the Docking station.
6. For INDOOR household use ONLY. Do not use the Appliance in outdoor, commercial or industrial environments.
7. Use only the original rechargeable battery and Docking station provided with the Appliance from the manufacturer. Non-rechargeable batteries are prohibited.
8. Do not use without dust bin and/or filters in place.
9. Do not operate the Appliance in an area where there are lit candles or fragile objects.

10. Do not use in extremely hot or cold environments (below -5°C/23°F or above 40°C/104°F).
11. Keep hair, loose clothing, fingers, and all parts of body away from any openings and moving parts.
12. Do not operate the Appliance in a room where an infant or child is sleeping.
13. Do not use Appliance on wet surfaces or surfaces with standing water.
14. Do not allow the Appliance to pick up large objects like stones, large pieces of paper or any item that may clog the Appliance.
15. Do not use Appliance to pick up flammable or combustible materials such as gasoline, printer or copier toner, or use in areas where they may be present.
16. Do not use Appliance to pick up anything that is burning or smoking, such as cigarettes, matches, hot ashes, or anything that could cause a fire.
17. Do not put objects into the suction intake. Do not use if the suction intake is blocked. Keep the intake clear of dust, lint, hair, or anything that may reduce air flow.
18. Take care not to damage the power cord. Do not pull on or carry the Appliance or Docking station by the power cord, use the power cord as a handle, close a door on the power cord, or pull power cord around sharp edges or corners. Do not run Appliance over the power cord. Keep power cord away from hot surfaces.
19. If the power cord is damaged, it must be replaced by the manufacturer or its service agent in order to avoid a hazard.
20. Do not use the Docking station if it is damaged. The power supply is not to be repaired and not to be used any longer if it is damaged or defective.
21. Do not use with a damaged power cord or receptacle. Do not use the Appliance or Docking station if it is not working properly, has been dropped, damaged, left outdoors, or come in contact with water. It must be repaired by the manufacturer or its service agent in order to avoid a hazard.
22. Turn OFF the power switch before cleaning or maintaining the Appliance.
23. The plug must be removed from the

receptacle before cleaning or maintaining the Docking station.

24. Remove the Appliance from the Docking station, and turn OFF the power switch to the Appliance before removing the battery for disposal of the Appliance.
25. The battery must be removed and discarded according to local laws and regulations before disposal of the Appliance.
26. Please dispose of used batteries according to local laws and regulations.
27. Do not incinerate the Appliance even if it is severely damaged. The batteries can explode in a fire.
28. When not using the Docking station for a long period of time, please unplug it.
29. The Appliance must be used in accordance with the directions in this Instruction Manual. Ecovacs Home Service Robotics cannot be held liable or responsible for any damages or injuries caused by improper use.
30. The robot contains batteries that are only replaceable by skilled persons. To replace the robot's battery, please contact Customer Service.
31. If the robot will not be used for a long time,

power OFF the robot for storage and unplug the Docking station.

32. **WARNING:** For the purposes of recharging the battery, only use the detachable supply unit CH2229 provided with the Appliance.

The lithium battery type suitable for CH2229 is Max. 8 cells, max. nominal voltage DC14.4V, rated capacity 5,900mAh. The battery must be removed and discarded according to local laws and regulations before disposal of the Appliance.











To satisfy RF exposure requirements, a separation distance of 20 cm or more should be maintained between this device and persons during device operation.

To ensure compliance, operations at closer than this distance is not recommended. The antenna used for this transmitter must not be co-located in conjunction with any other antenna or transmitter.

Device Update

Typically, some devices are updated bi-monthly, but not always so specific.

Some devices, especially those that went on sale more than three years ago, will only be updated if a critical vulnerability is found and fixed.

	Short-circuit-proof safety isolating transformer
	Switch mode power supply
	For indoor use only
	Direct current
	Alternating current
	Caution: hot surface
	This product conforms to the applicable EC Directives.
	Before charging, read the instructions.
	This product conforms to the applicable UK legislation.
	Polarity of the charging port
	Time-lag miniature fuse-link

For EU Countries

For EU Declaration of Conformity information, visit <https://www.ecovacs.com/global/compliance>.

For UK

For UK Declaration of Conformity information, visit <https://www.ecovacs.com/global/compliance>.



Correct Disposal of this Product

This marking indicates that this product should not be disposed of with other household waste throughout the EU. To prevent possible harm to the environment or human health from uncontrolled waste disposal, recycle it responsibly to promote the sustainable reuse of material resources. To recycle your used device, please use the return and collection systems or contact the retailer where the product was purchased. They can safely recycle this product.

The remote surveillance is for the absolute private use of non-public, private owned places for the pure self-protection and single control intended only. Please be aware of the local data protection based legal obligations in case of use. No surveillance of public places,

especially with clandestine intent and/or on the part of the employer without justified reasons. Such not justified use is in the risk and responsibility of the user only.

European Union Compliance Statement

Information on Disposal for Users of Waste Electrical & Electronic Equipment



This symbol on the product or on its packaging indicates that used electrical and electronic products should not be mixed with unsorted municipal waste. For proper treatment, it is your responsibility to dispose of your waste equipment by arranging to return it to designated collection points.

Disposing of this product correctly will help save valuable resources and prevent any potential negative effects on human health and the environment, which could otherwise arise from inappropriate waste handling.

To return your used device, please use the return and collection systems or contact the retailer where the product was purchased, which is free of charge, please contact your local authority for further details of your nearest designated collection point.

Penalties may be applicable for incorrect disposal of this waste, in accordance with your national legislation.

Information on Disposal for Users of used batteries



This symbol means that batteries and accumulators, at their end-of-life, should not be mixed with unsorted municipal waste. Your participation is an important part of the effort to minimize the impact of batteries and accumulators on the environment and on human health. For proper recycling you can return this product or the batteries or accumulators it contains to your supplier or to a designated collection point, which is free of charge. Disposing of this product correctly will help save valuable resources and prevent any potential negative effects on human health and the environment, which could otherwise arise from inappropriate waste handling. Penalties may be applicable for incorrect disposal of this waste, in accordance with your national legislation. there are separate collection systems for used batteries and accumulators.

Please, dispose of batteries and accumulators correctly at your local community waste collection/recycling center.

Restriction of the use of certain hazardous substances (RoHS) Directive

Ecovacs Home Service Robotics Co., Ltd. hereby declares the whole product including parts (cables, cords, and so on) meets the requirements of RoHS Directive 2011/65/EU and amendment Commission Delegated Directive (EU) 2015/863 on the restriction of the use of certain hazardous substances in electrical and electronic equipment ("RoHS recast" or "RoHS 2.0").

Radio Equipment Directive

Ecovacs Home Service Robotics Co., Ltd. hereby declares that the product listed in this section comply with the essential requirements and other relevant provisions of the Radio Equipment Directive 2014/53/EU.

Europe Authorised Representative:



ECOVACS Europe GmbH
Holzstrasse 2 | D-40221 Düsseldorf | Germany

Ecovacs Home Service Robotics Co., Ltd. hereby declares that the product comply with the essential requirements and other relevant provisions of the RoHS Directive 2011/65/EU and amendment Commission Delegated Directive (EU) 2015/863, the Radio Equipment Directive 2014/53/EU.

The declaration of conformity can be viewed at the following address: <https://www.ecovacs.com/global/compliance>.

PACKAGE CONTENTS



Robot

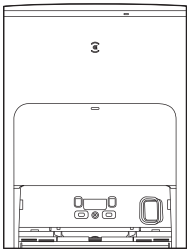

OMNI Station

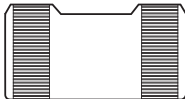

Base

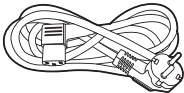

Power Cord



Floating Rubber Brush

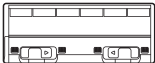

Floating Rubber Brush Cover

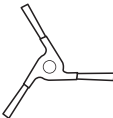

Side Brush



Instruction Manual

Note: Figures and illustrations are for reference only and may differ from actual product appearance. Product design and specifications are subject to changes without notice.

PRODUCT DIAGRAM

1 Robot

Button on DEEBOT

Short Press: Start/Pause

Long Press for 3s: Return to charge

Camera Indicator Light

TrueDetect 3D Sensor

AIVI Camera

Top Cover

Anti-collision Sensors and Bumper

Solid-state LiDAR

- Press the Reset Button, the YIKO Assistant will guide you to connect DEEBOT to your phone.
- Restore to factory settings: Long press the Reset Button for 5s.

2 Dust Bin

High Efficiency Filter

Release Button

Power Switch
"I"=ON
"O"=OFF

Wi-Fi Status Indicator/
Reset Button

Dust Disposal Port

Dust Bin Handle

Filter Net

3 Bottom View

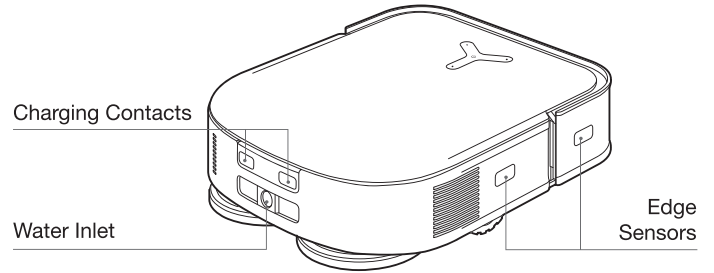
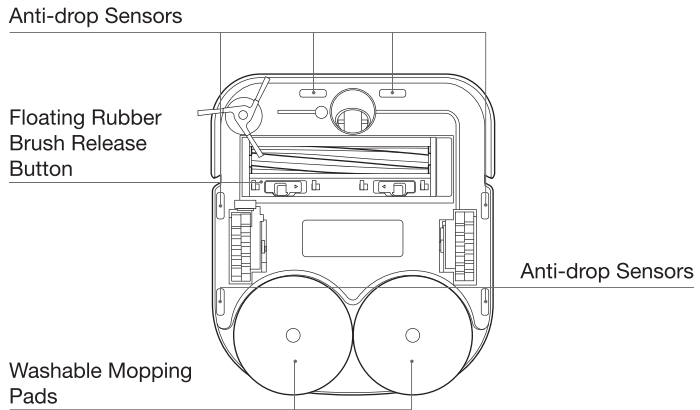
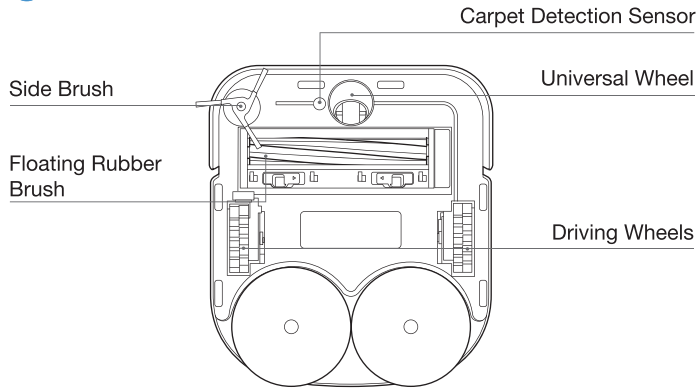

4 Station(Front)

Note:

- If the Light Strip is flashing red, please check the reason in ECOVACS HOME App.
- If DEEBOT fails to charge, please wipe Charging Contacts with a clean and dry cloth.

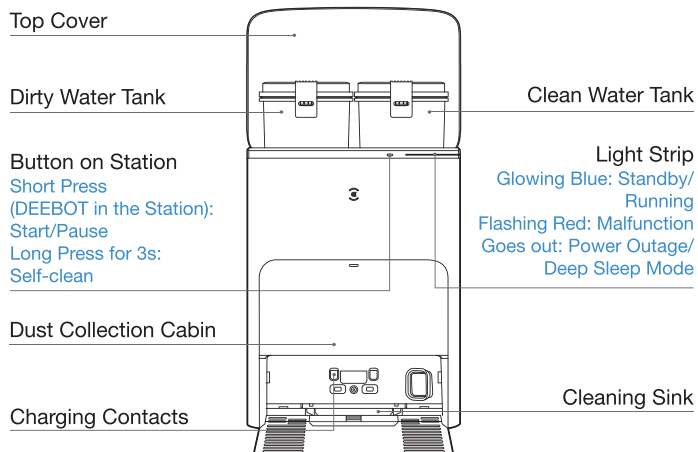

5 Dust Bag

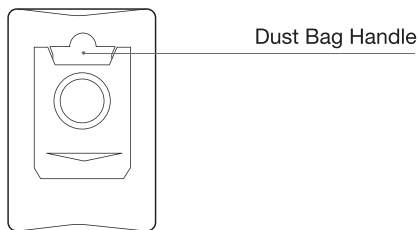

6 Station(Back)

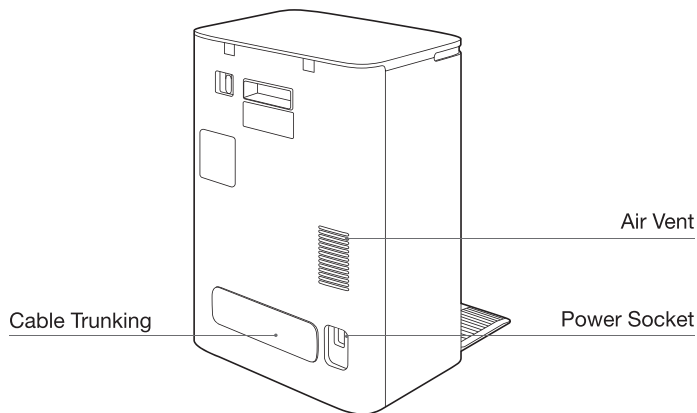

SENSORS

Name	Functional Description
Solid-state LiDAR	With Laser Ranging-measuring the distance between DEEBOT and surroundings through the time difference of reflection, it can map according to the objects around while DEEBOT is moving. Detection of 10m.
Microphone	Vibrating the diaphragm through air by human voice, it can realize Voice Recording and ask DEEBOT to complete the assigned work by Voice Control. Effective wake of 5m.
TrueDetect 3D Sensor	The sensor emits infrared rays and receives the light reflected from obstacles in front of it. With Infrared Ranging-measuring the distance between DEEBOT and surroundings through the time difference of reflection, it can identify and avoid the obstacles nearby. The measurement range is 0.8m.
AI Camera	With AI Camera's surrounding image collection, it can realize the video recording and meanwhile assist in drawing the 3D map. Through the interaction with the MIC, it can realize the Remote Voice Call. FOV: Vertical 112°, Horizontal 138°.
Anti-drop Sensor	With Infrared Ranging-detecting the distance between the bottom of DEEBOT and ground by Infrared Sensor at the bottom, DEEBOT will not move forward when there are stairs in front (For example: White ground height greater than 55mm. Black ground height greater than 30mm,) or the identified distance exceeds the present one, realizing the Anti-drop.
Carpet Detection Sensor	The ultrasound probe can emit ultrasonic waves with a frequency of 300KHZ. The energy of the ultrasonic waves is absorbed by the carpet. If the reflected energy is below the threshold, the DEEBOT recognizes the presence of the carpet.
Anti-collision Sensor	When the transmitted signal is blocked by an obstacle, the signal receiver will not be able to receive the signal. With this principle, DEEBOT will avoid obstacles when colliding with them.
Edge Sensor	With ToF distance measurement, DEEBOT can detect the distance between itself and objects on its right side. When there is a wall or obstacle on the right side, DEEBOT will perform edge cleaning to avoid missing spots or collisions.

NOTES BEFORE CLEANING

Tidy up the area to be cleaned by putting furniture, such as chairs, in their proper place.

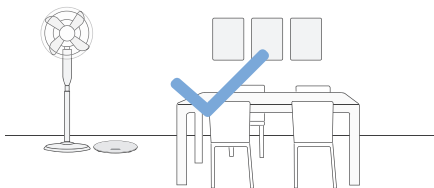

During the first use, make sure each room door is open to help DEEBOT fully explore your house.

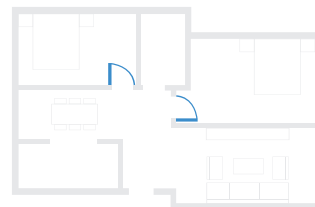

It may be necessary to place a physical barrier at the edge of a drop to stop the unit from falling over the edge.

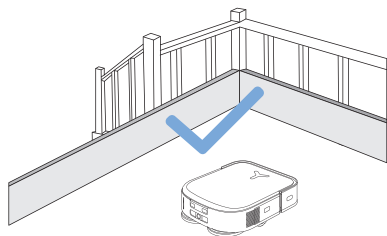

Make sure areas to be cleaned are well illuminated so AIVI Camera works properly. Remove power cords and small objects from the floor to ensure cleaning efficiency.

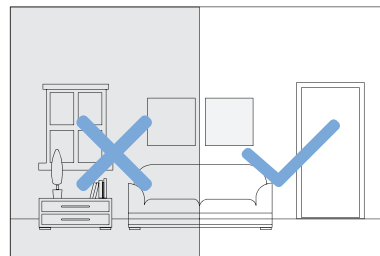



Put away objects including cables, cloths and slippers, etc. on the floor to improve the cleaning efficiency.



Before using the product on a rug with tasseled edges, please fold the rug edges under.



Please do not stand in narrow spaces, such as hallways, and make sure not to block the AIVI Camera.



Clean the AIVI Camera and TrueMapping Distance Sensor with a clean cloth, and avoid using any detergent or cleaning spray.

QUICK START

Before using DEEBOT, please remove all protective materials.

Installation

The sound of Click indicates proper installation.

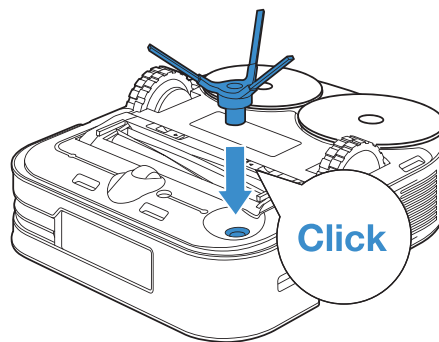

DOWNLOAD THE ECOVACS HOME APP

To enjoy all available features, it is recommended to control your DEEBOT via the ECOVACS HOME App.

1. Scan the QR Code under the Top Cover to download the App.

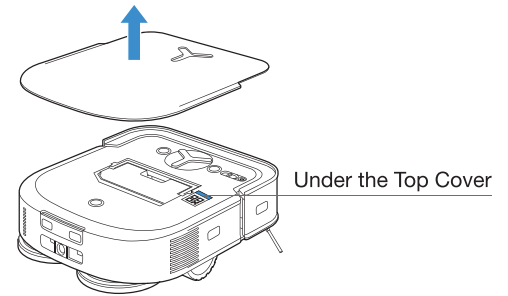
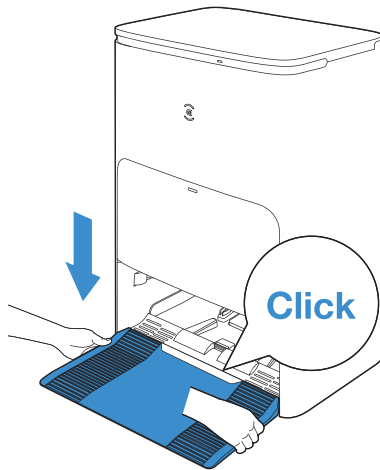



2. Search the ECOVACS HOME to download the App.



CONNECT DEEBOT WITH APP

1. Via Bluetooth:

Turn on the DEEBOT and mobile phone Bluetooth. Allow the App to obtain mobile phone Bluetooth permission. Tap  to scan the QR Code on DEEBOT or tap  in the App to find nearby DEEBOT.

2. Via Wi-Fi:

You can connect DEEBOT with App via Wi-Fi by ignoring Bluetooth in the App.

Note: DEEBOT does not support 5GHz network. Please connect via Bluetooth for a better experience.

Wi-Fi Network Requirements:

- You are using a 2.4GHz or 2.4/5 GHz mixed network.
- Your router supports 802.11b/g/n and IPv4 protocol.
- Do not use a VPN (Virtual Private Network) or Proxy Server.
- Do not use a hidden network.
- WPA and WPA2 using TKIP, PSK, AES/CCMP encryption.
- WEP EAP (Enterprise Authentication Protocol) is not supported.
- Use Wi-Fi channels 1-11 in North America and channels 1-13 outside North America (refer to local regulatory agency).
- If you are using a network extender/repeater, the network name (SSID) and password are the same as your primary network.
- Please enable the WPA2 on your router.

Please be aware that the realization of intelligent functions such as remote startup, voice interaction, 2D/3D map display and control settings, and personalized cleaning (depending on different products) requires users to download and use ECOVACS HOME App, which is constantly updated. You need to agree to our Privacy Policy and User Agreement before we can process some of your basic and necessary information and enable you to operate the product. If you do not agree with our Privacy Policy and User Agreement, some of the aforementioned intelligent functions cannot be realized through ECOVACS HOME App, but you can still use the basic functions of this product for manual operation.

Wi-Fi Indicator Light

	Flashing Blue Light	Disconnected to Wi-Fi
	Solid Blue Light	Connected to Wi-Fi

CHARGING DEEBOT

1 Assemble the Station

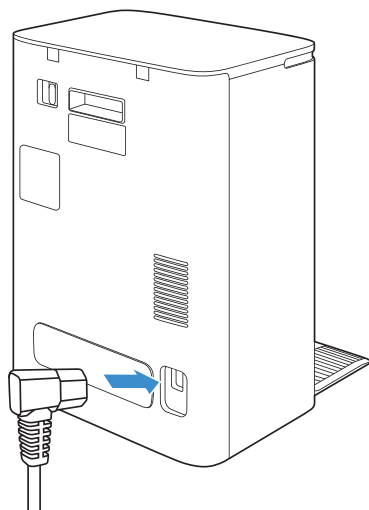

2 Place the Station

Keep the area around the Station clear of objects especially objects with reflective surfaces.

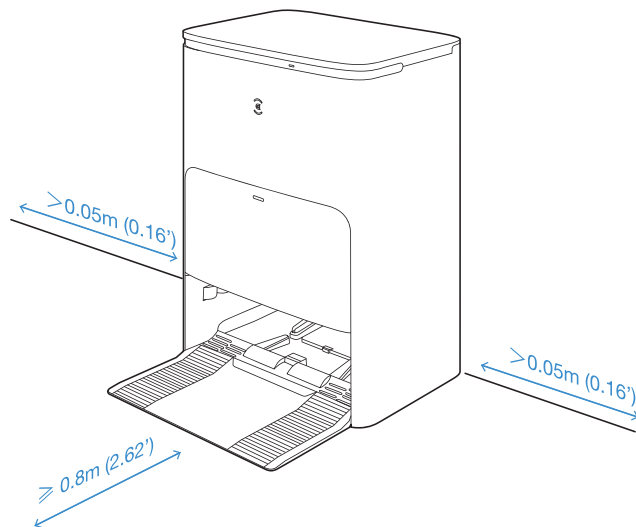

- If there are reflective objects such as mirrors and reflective skirting lines near the Station, the bottom 14cm of that should be covered.
- Do not place the Station under direct sunlight.
- It is recommended to place the Station on the hard floor to experience complete functions of the robot.
- Place Station in a location with a strong Wi-Fi signal.

3 Add water to Clean Water Tank

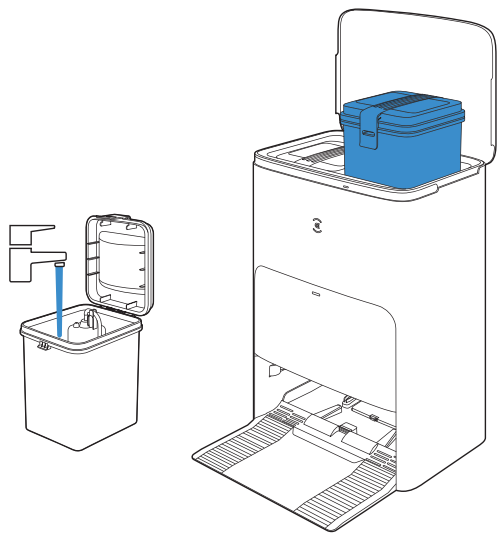

Note: It is recommended to use ECOVACS DEEBOT Cleaning Solution (sold separately). Using other cleaning solution may cause DEEBOT slipping, water tank block and other problems.

4 Power ON

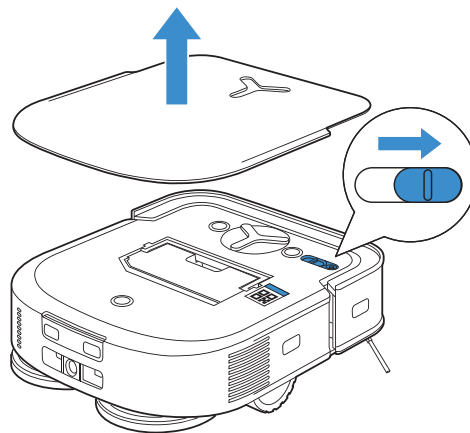

Note: "I" = ON, "O" = OFF.

- DEEBOT cannot be charged when being powered OFF.
- When DEEBOT is not working, it is recommended to keep it switched ON and charging.

5 Charge DEEBOT

Make sure the Station is connected to the power supply. Use the ECOVACS HOME App or voice to recall DEEBOT to enter the Station to charge it up.

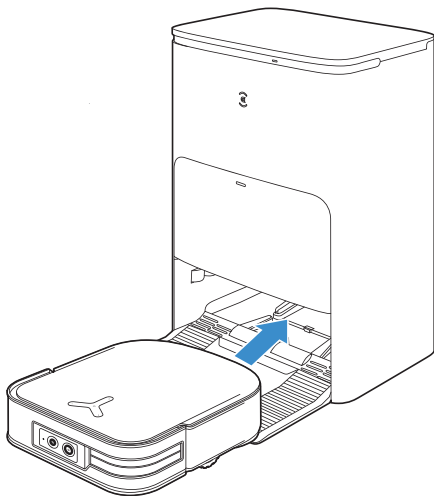

- It is recommended that DEEBOT start cleaning from the Station. Do not move the Station while cleaning.

6 Operating DEEBOT

1. Create a map

Order the DEEBOT to map by ECOVACS HOME App or voice.

When creating a map for the first time, please follow DEEBOT to help eliminate some minor issues.

When mapping, DEEBOT will explore the house environment automatically. The exploration path may be different from cleaning path.

Set up Virtual Boundary via the App: Map>  >Virtual Boundary

2. Start vacuum

When mopping, DEEBOT will recognize floor types. DEEBOT is able to lift mops automatically when encountering carpet. Please don't use the DEEBOT on shaggy rugs or carpets with fibres longer than 10mm. It is recommended to fold up the shaggy rugs with fibres longer than 10mm during the cleaning process, or set the shaggy carpeted area as a No-Entry Zone by setting Virtual Boundary in the ECOVACS HOME App.

Before first vacuuming, please make sure the DEEBOT is in the Station and fully charged. Tap  on DEEBOT to start.

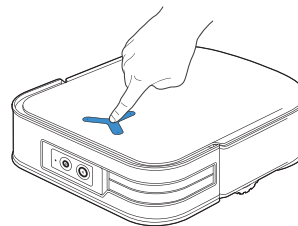

Note:

- Do not frequently remove washable mopping pads.
- Do not use a rag or any other object to scratch the Mopping Pad Plates.
- When the ECOVACS HOME App prompts that the mops need to be replaced, please replace them in time. Explore more accessories at ECOVACS HOME App or at <https://www.ecovacs.com/global>.

3. Pause

Tap  on DEEBOT to pause during vacuuming.

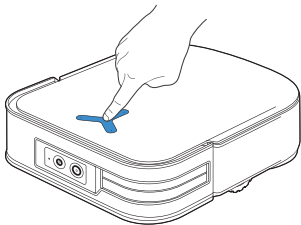

4. Wake up

The indicator light will go out after the DEEBOT is paused for a few minutes. Press  on DEEBOT to wake it up. After stopping working for about 1h, DEEBOT may enter standby mode.

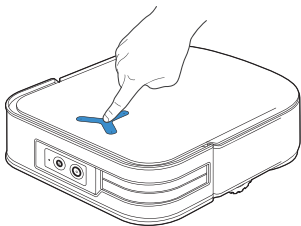

5. Back to Station

Use the ECOVACS HOME App or voice to recall DEEBOT to enter the Station to charge it up. Long press  for 3s on the DEEBOT can also recall it.

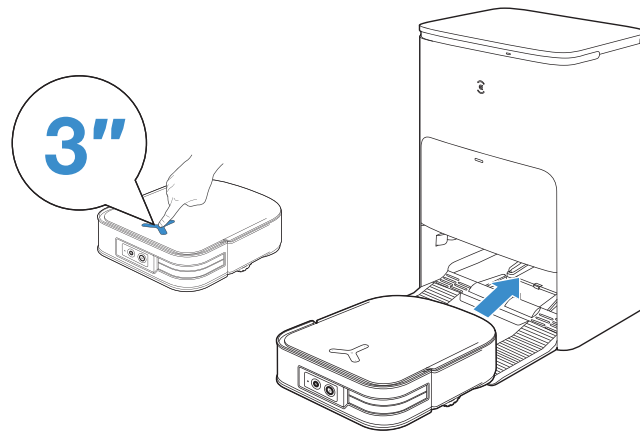

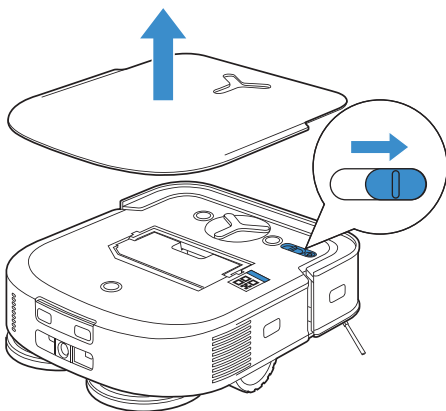

6. Deep Sleep Mode

DEEBOT will enter deep sleep mode to protect the battery if the DEEBOT stays outside the Station for about 5h. Please switch OFF and ON to wake up the DEEBOT.



7 Station

When DEEBOT is in the Station, short press  to start/pause. Long press  to self-clean the Station.

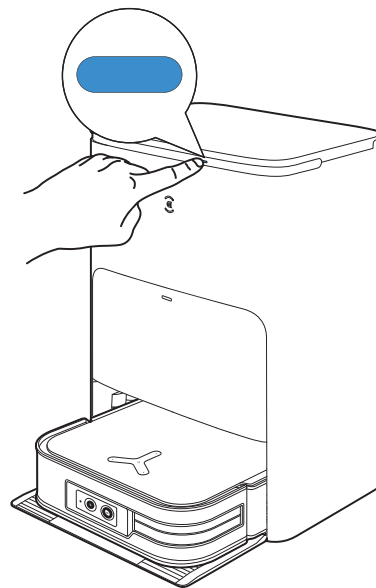

REGULAR MAINTENANCE

To keep DEEBOT running at peak performance, perform maintenance tasks and replace parts at the following frequencies:

Robot Part	Maintenance Frequency	Replacement Frequency
Washable Mopping Pad	/	Every 1-2 months
Dust Bag	/	Every 2-3 months
Side Brush	Once every 2 weeks	Every 3-6 months
Floating Rubber Brush	Once per week	Every 6-12 months
High Efficiency Filter	Once per week	Every 3-6 months
TrueDetect 3D Sensor AIVI Camera Universal Wheel Anti-Drop Sensors Bumper Charging Contacts Solid-state LiDAR	About 1 month	/
Cleaning Sink	Once every 2 weeks	/
Clean Water Tank	Once every 3 months	/
Dirty Water Tank	Once per month	/
Dust Collection Cabin	Once per week	/
Station	Once per week	/

Before performing cleaning and maintenance tasks on DEEBOT, turn the robot OFF and unplug the Station.

Note: ECOVACS manufactures various replacement parts and fittings. Please contact Customer Service for more information on replacement parts.

MAINTAIN DUST BIN AND FILTER

1

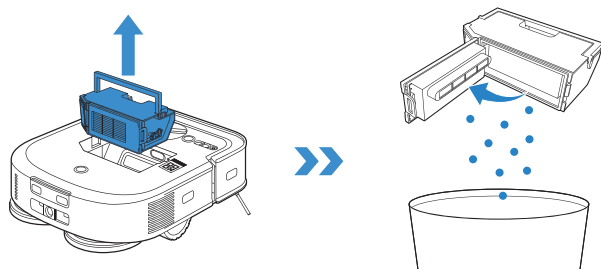

2

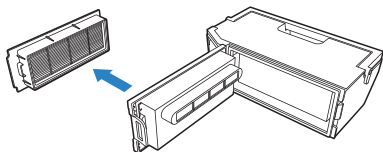

3

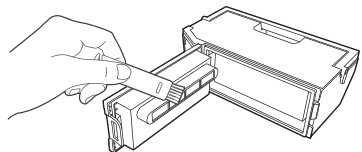

4

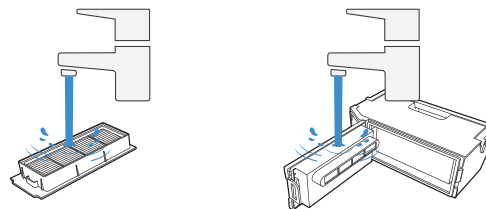

Note:

- Please rinse the filter with water as shown above.
- Do not use finger or brush to clean the High Efficiency Filter.

5

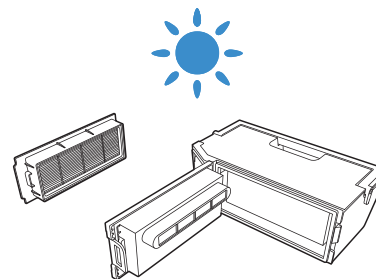

Note: Completely dry the filter before use.

Explore more accessories at ECOVACS HOME App or at <https://www.ecovacs.com/global>.

MAINTAIN FLOATING RUBBER BRUSH AND SIDE BRUSH

1 Floating Rubber Brush

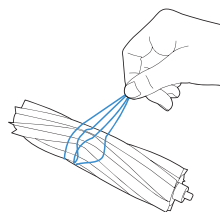
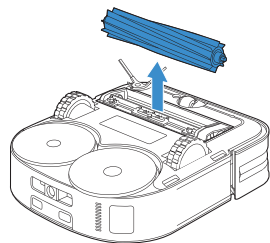
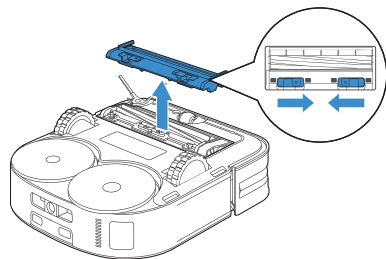

2 Side Brush

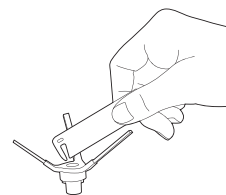
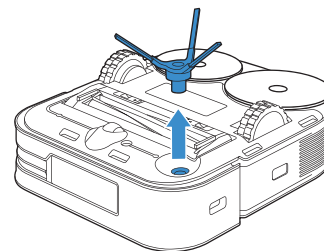

MAINTAIN OTHER COMPONENTS

Note: Wipe the components with a clean, dry cloth. Avoid using cleaning sprays or detergents.

1

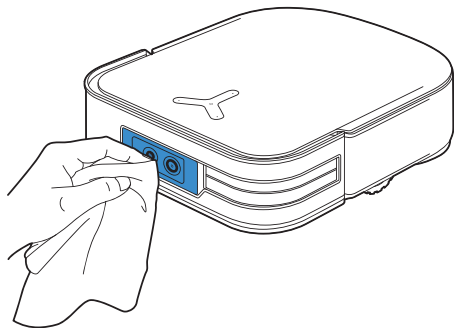

3

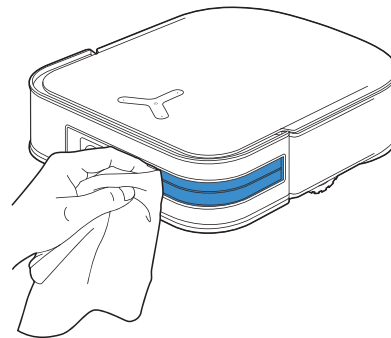

2

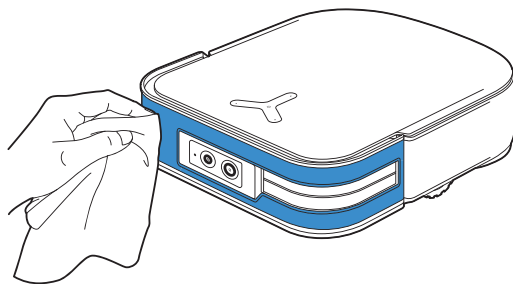

4

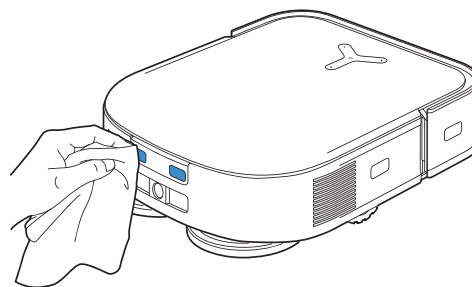

5

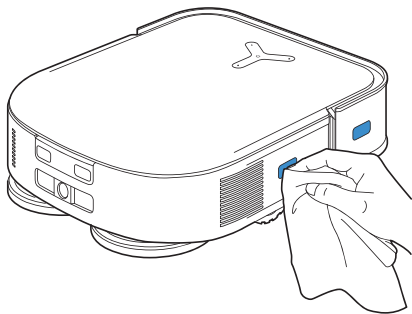

7

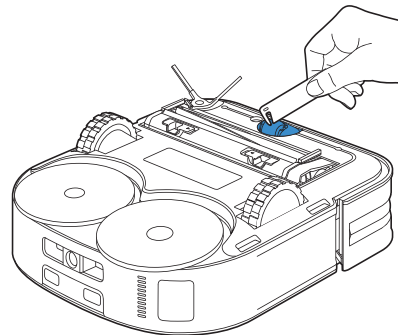

6

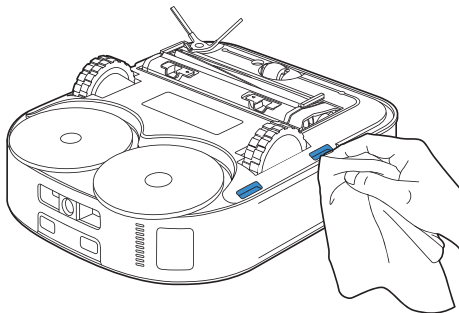

8

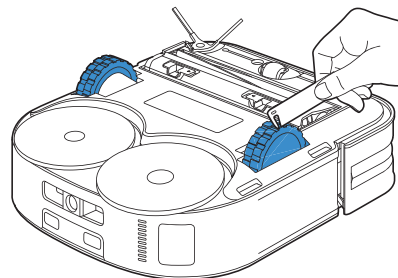

MAINTAIN STATION

- Note:**
- Please don't enable self-clean when DEEBOT is working.
 - If there is remaining dirty water in the Cleaning Sink, the Station will drain the water first after a long press. Please long press  to start self-clean.

1 Long press  to direct DEEBOT to exit from Station

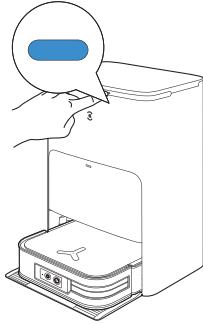

2 Clean Cleaning Sink

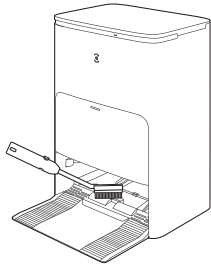

3 The Station will drain the water out of Cleaning Sink automatically

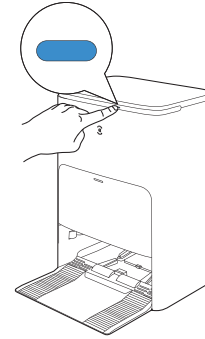

4 Empty Dirty Water Tank

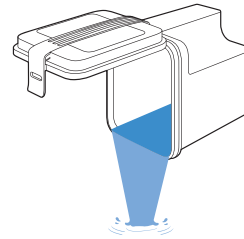

MAINTAIN CLEANING SINK

1 Take the Detachable Tray and Base Filter to Wash

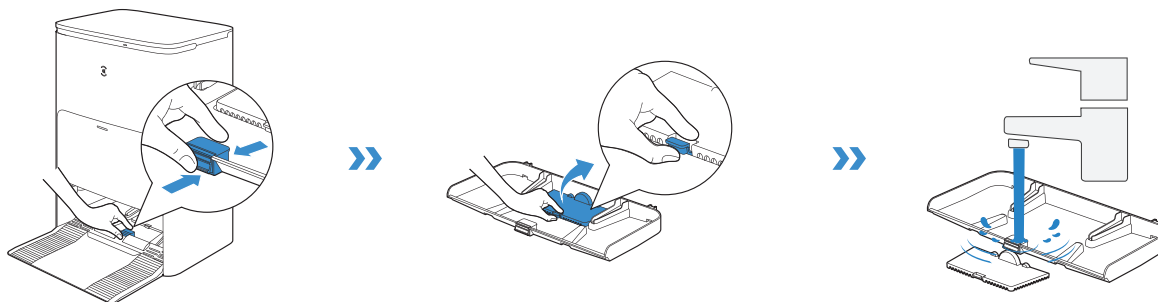

2 Install

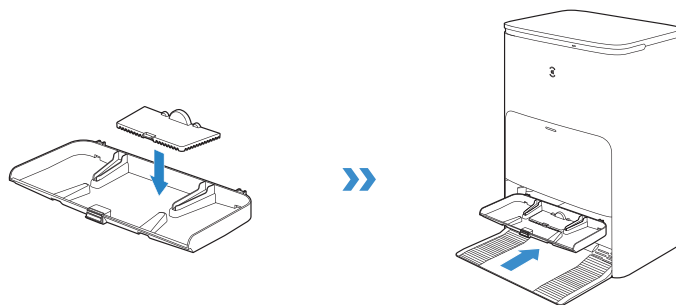

Note: Please install Cleaning Sink properly to prevent malfunction.

MAINTAIN DUST BAG

1 Discard the Dust Bag

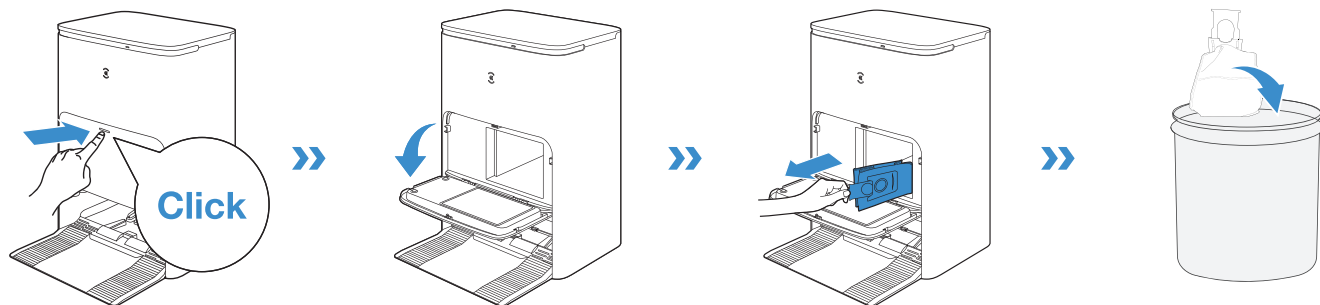

Hold the Handle to lift out the Dust Bag, which can effectively prevent dust leakage.

2 Clean the Dust Collection Cabin with a Dry Cloth and Put a New Dust Bag in

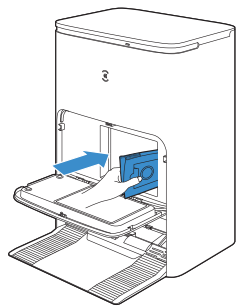

3 Close the Dust Collection Cabin

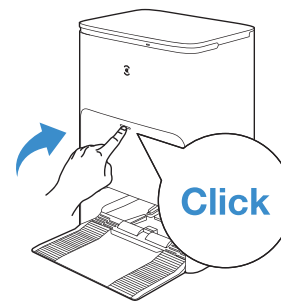

STORAGE

Please fully charge and switch OFF the DEEBOT before storage. Please recharge it every 1.5 months to prevent the battery from over-discharge.

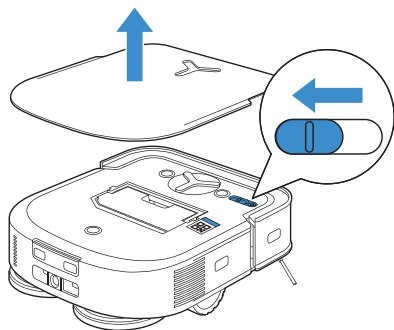

Note:

- DEEBOT can't be charged when the power is turned off.
- If the battery is over-discharged or not used for a long time, the DEEBOT may not be charged. Please contact ECOVACS for help. Do not disassemble by yourself.

TROUBLESHOOTING

No.	Malfunction	Possible Causes	Solutions
1	DEEBOT is not able to connect to ECOVACS HOME App.	Incorrect home Wi-Fi username or password entered.	Enter the correct home Wi-Fi username and password.
		DEEBOT is not within range of your home Wi-Fi signal.	Make sure DEEBOT is within range of your home Wi-Fi signal. Try to stay as close to the Wi-Fi signal as possible.
		DEEBOT is not in the configuration state.	Press the Reset Button to connect DEEBOT to your phone by Bluetooth. If failed, please press the Reset Button and  to connect via ECOVACS HOME App.
		Incorrect App installed.	Please download and install ECOVACS HOME App.
		There is no home Wi-Fi on the Wi-Fi list.	1. Check if the Wi-Fi name contains special characters. Please do not use special characters like ! @#& ¥ % / \ , . 2. Do not use a 5Ghz network.
2	The map is lost.	The map might be lost if you move DEEBOT when cleaning.	Move DEEBOT to the front of the Station to retrieve the map. Find the restored map in the Map Management and tap "Use This Map" to retrieve it. You can lock the map in the ECOVACS HOME App. If this problem persists after trying the above solutions, please restart mapping.
3	Unable to create furniture map on App.	Move DEEBOT when cleaning might cause the map to be lost.	During cleaning, do not move DEEBOT.
		Auto cleaning is not finished.	Make sure DEEBOT automatically return to the Station after cleaning.
4	DEEBOT Side Brush drops out of place during use.	The Side Brush is not properly installed.	Make sure the Side Brush clicks into place.

No.	Malfunction	Possible Causes	Solutions
5	No signal found. Unable to return to the Station.	The Station is incorrectly placed.	Please place the Station correctly according to the instructions in the [Charging DEEBOT] section.
		The Station is out of power or manually moved.	Check whether the Station is connected to power supply. Do not manually move the Station.
		DEEBOT does not start cleaning from the Station.	It is recommended that DEEBOT start cleaning from the Station.
		The charging route is blocked. For example, the door of the room with the Station is closed.	Keep the charging route clear.
6	DEEBOT returns to the Station before it has finished cleaning.	The room is so large that DEEBOT needs to return to recharge.	Please enable Continuous Cleaning. For more details, please follow the App instruction.
		DEEBOT is unable to reach certain areas blocked by furniture or barriers.	Tidy up the area to be cleaned by putting furniture and small objects in their proper place.
7	DEEBOT is unable to charge.	DEEBOT is not switched ON.	Switch ON DEEBOT.
		DEEBOT's Charging Contacts are not connected to the Station Pins.	Make sure that the robot's Charging Contacts have connected to the Station Pins and  flashes. Check whether DEEBOT's Charging Contacts and the Station Pins are dirty. Please clean these parts according to the instructions in the [Maintenance] section.
		The Station is not connected to the power supply.	Make sure the Station is connected to the power.
8	Running is very loud during cleaning.	Side brush and floating rubber brush are entangled. Dust bin and filter are blocked.	It is recommended to clean the side brush, floating rubber brush, dust bin, filter, etc. regularly.
		DEEBOT is in Max Mode.	Switch to Standard Mode.
9	DEEBOT gets stuck while working and stops.	DEEBOT is tangled with something on the floor (electrical wires, curtains, carpet fringing, etc.).	DEEBOT will try various ways to free itself. If it is unsuccessful, manually remove the obstacles and restart.
		DEEBOT might be stuck under furniture with an entrance of similar height.	Please set a physical barrier, or set a Virtual Boundary via the ECOVACS HOME App.
		DEEBOT is stuck in a narrow area.	Tidy up the house. Or set a physical barrier. Or set a Virtual Boundary via the ECOVACS HOME App.

No.	Malfunction	Possible Causes	Solutions
10	The following problems appear when DEEBOT is working: disordered cleaning route, deviation from the cleaning route, repeated cleaning, or missing of small areas to be cleaned. (If there is a large area that has not been cleaned temporarily, DEEBOT will automatically clean the missing area. Sometimes DEEBOT will re-enter a cleaned room, which may not be a repeated cleaning, but DEEBOT finding any missing area.)	Objects such as wires and slippers placed on the ground block the DEEBOT.	Please tidy up the scattered objects on the ground such as wires, slippers before cleaning. If there is any area missing, DEEBOT will clean the missing area by itself, please do not interfere (such as moving DEEBOT or blocking the route).
		It may be that the Driving Wheels slip on the ground when DEEBOT climbs steps, thresholds and door bars, thus affecting its judgment of the whole house environment.	It is recommended to close the door of this area and clean the area separately. After cleaning, DEEBOT will return to the starting location. Please rest assured to use.
		Work on freshly waxed and polished floors or smooth tiles, resulting in less friction between the Driving Wheels and the floor.	Please wait for wax to dry before cleaning.
		Due to different home environments, some areas cannot be cleaned.	Tidy up the home environment to ensure that DEEBOT can enter for cleaning.
		The TrueMapping Distance Sensor is dirty or blocked by foreign matters.	Wipe the TrueMapping Distance Sensor with a clean soft cloth or remove foreign matters.
11	Video Manager cannot open or has no screen.	Wi-Fi connection failed.	Check the Wi-Fi connection status. DEEBOT must be in an area with good Wi-Fi signal to enable the Video Manager.
		Video Manager is not authorized.	Please check your consent in the Privacy Policy before using the robot.
		Due to the network latency, you may not be able to open Video Manager temporarily.	Try again later.
		The AI VI Camera is blocked.	Remove the shield.
12	Delay in remote control.	The Wi-Fi signal is poor, causing the video loading to be slow.	Use DEEBOT in areas with good Wi-Fi signal.

No.	Malfunction	Possible Causes	Solutions
13	AIVI Camera cannot recognize objects.	The cleaning area is not well illuminated.	Smart Recognition requires sufficient lighting. Please make sure the areas to be cleaned are well illuminated.
		AIVI Camera lens is dirty or blocked.	Clean the lens with a clean soft cloth, and make sure the sensor is not blocked. Avoid using any detergent or cleaning spray while cleaning.
14	After returning to the Station, DEEBOT does not empty the Dust Bin.	The Auto-Empty function has not been turned on in the ECOVACS HOME App.	Turn on the Auto-Empty function in the ECOVACS HOME App.
		Dust Bag is not installed in the Station.	Install the Dust Bag, and close the Dust Collection Cabin .
		Manually moving DEEBOT back to the Station might not trigger Auto-Empty function.	It is recommended to let DEEBOT return to the Station on its own. Please do not manually move it.
		DEEBOT automatically returns to the Station in Video Manager mode.	DEEBOT doesn't do cleaning task and empty the Dust Bin in Video Manager mode. This is a normal phenomenon, please rest assured to use.
		In Do Not Disturb mode, DEEBOT will not empty the dust after returning back to the Station.	Turn off Do Not Disturb mode in ECOVACS HOME App or manually start dust-emptying.
		The Station detects a decrease in empty efficiency.	Replace the Dust Bag according to the [Maintenance] section and close the Dust Collection Cabin. If the Dust Bag is not full when ECOVACS HOME App prompts, you can put it back again.
		If the above possible causes have been ruled out, components of the Station may be abnormal.	Please contact Customer Care for help.
15	Fail to empty the Dust Bin.	The Station detects a decrease in empty efficiency.	Replace the Dust Bag according to the [Maintenance] section and close the Dust Collection Cabin. If the Dust Bag is not full when ECOVACS HOME App prompts, you can put it back again.
		The outlet of Dust Bin is blocked by foreign objects.	Remove the Dust Bin and clean the foreign objects on the outlet.
16	The inner side of Dust Collection Cabin is dirty.	Fine particles are absorbed in the inner side of Dust Collection Cabin through the Dust Bag.	Clean the inner side of Dust Collection Cabin.
		The Dust Bag is broken.	Check the Dust Bag. Replace it.
17	Dust leakage occurs during working.	The outlet of Dust Bin is blocked by foreign objects.	Remove the Dust Bin and clean the foreign objects on the outlet.

No.	Malfunction	Possible Causes	Solutions
18	Mopping Pad Plate cannot rotate.	The Mopping Pad Plate is blocked by foreign objects.	Clean the foreign objects.
		Mopping Pad Plate is not correctly installed.	Please install Mopping Pad Plate correctly. A sound of Click means properly installation.
19	DEEBOT does not respond to the Station instruction.	DEEBOT is not in the Station.	Please make sure DEEBOT is in the Station.
20	Driving wheels are blocked.	Driving wheels are blocked by foreign objects.	Please rotate and press the driving wheels to check whether there is any foreign object wrapped or stuck. If there is any foreign object, please clean it in time. If this problem persists, please contact Customer Care for help.
21	When the water in the Cleaning Sink is full and cannot be drained out, the voice reports that the Cleaning Sink is full.	The Dirty Water Tank is not properly installed.	Tap down on the Dirty Water Tank to ensure it is properly installed.
		The sealing plugs in the Dirty Water Tank is not installed properly.	Make sure to check that the sealing plugs are properly installed.
		The Station cannot drain water normally.	Long press  to see whether the Station can properly draw the water. If the water is successfully drawn, wipe dry the Water Overflow Sensor of the Cleaning Sink. If the Station fails to draw the water, check between the Dirty Water Tank and the Station for foreign object and clean it.
		The suction port of the Cleaning Sink is blocked by foreign object.	Ensure that there is no foreign object in the suction port of the Cleaning Sink .
		The voice prompt still exists after trying the above solutions.	Unplug the Station and plug it again. If this problem persists, please contact Customer Care for help.
		The Cleaning Sink and Base Filter are dirty.	Wash the Cleaning Sink and Base Filter with clean water.

TECHNICAL SPECIFICATIONS

Model	DEX86
Rated Input	20V === 2A
Charging Time	About 5.5h
Station Model	CH2229
Rated Input	220-240V ~ 50-60Hz
Rated Input Current(Charging)	0.5A
Power(Emptying)	1000W
Power(Hot Water Washing Mop)	1650W
Rated Output	20V === 2A

Output power of the Wi-Fi module is less than 100mW.

Note: Technical and design specifications may be changed for continuous product improvement.

Explore more accessories at <https://www.ecovacs.com/global>.

Ecovacs Home Service Robotics Co., Ltd.

No.518 Songwei Road, Wusongjiang Industry Park, Guoxiang Street,
Wuzhong District, Suzhou, Jiangsu, China,

451-2228-2716