



# DEEBOT PLUS

**Instruction Manual/Manuel d'instructions/  
Manual de instrucciones**

# Important Safety Instructions

## IMPORTANT SAFETY INSTRUCTIONS

### READ ALL INSTRUCTIONS BEFORE USING THIS APPLIANCE.

### SAVE THESE INSTRUCTIONS

For Household use only

When using an electrical appliance, basic precautions should always be followed, including the following:

**WARNING:** Read all safety warnings and instructions. Failure to follow the warnings and instructions may result in electric shock, fire or serious injury.

**WARNING:** To reduce the risk of fire, electric shock, or injury:

1. Do not allow to be used as a toy. Close attention is necessary when used by or near children.
2. Clear the area to be cleaned. Remove power cords and small objects from the floor that could entangle the Appliance. Tuck rug fringe under the rug base, and lift items such as curtains and tablecloths off the floor.
3. If there is a drop off in the cleaning area due to a step or stairs, you should operate the Appliance to ensure that it can detect the step without falling over the edge. It may become necessary to place a physical barrier at the edge to keep the unit from falling. Make sure the physical barrier is not a trip hazard.
4. Only use as described in this manual. Only use attachments recommended or sold by the manufacturer.
5. Please make sure your power supply voltage matches the power voltage marked on the Docking Station.
6. Do not handle plug or appliance with wet hands.
7. Non-rechargeable batteries are prohibited.
8. Do not use without Auto-Empty Dust Bin and/or filters in place.
9. Do not operate the vacuum in an area where there are lit candles or fragile objects on the floor to be cleaned.
10. Do not use and store in extremely hot or cold environments (below -5°C /23°F or above 40°C/104°F). Please charge the robot

in temperature above 0°C/32°F and below 40°C/104°F.



11. Keep hair, loose clothing, fingers, and all parts of body away from any openings and moving parts.
12. Do not operate the Appliance in a room where an infant or child is sleeping.
13. For INDOOR use ONLY. Do not use the Appliance in outdoor, commercial or industrial environments. Do not use Appliance on wet surfaces or surfaces with standing water.
14. Do not allow the Appliance to pick up large objects like stones, large pieces of paper or any item that may clog the Appliance.
15. Do not use Appliance to pick up flammable or combustible materials such as gasoline, printer or copier toner, or use in areas where they may be present.
16. Do not use Appliance to pick up anything that is burning or smoking, such as cigarettes, matches, hot ashes, or anything that could cause a fire.
17. Do not put any object into openings. Do not use with any opening blocked; keep free of dust, lint, hair, and anything that may reduce air flow.
18. Take care not to damage the power cord. Do not pull on or carry the Appliance or Docking Station by the power cord, use the power cord as a handle, close a door on the power cord, or pull power cord around sharp edges or corners. Do not run Appliance over the power cord. Keep power cord away from hot surfaces. Do not unplug by pulling on cord. To unplug, grasp the plug, not the cord.
19. If the power cord is damaged, it must be replaced by the manufacturer or its service agent in order to avoid a hazard.
20. Do not use the Docking Station if it is damaged.
21. Do not use with a damaged power cord or plug. Do not use the Appliance or Docking Station if it is not working properly, has been dropped, damaged, left outdoors, or come in contact with water. It must be repaired by the manufacturer or its service agent in order to avoid a hazard.
22. Turn OFF the power switch before cleaning or maintaining the Appliance. Turn off all

- controls before unplugging.
23. The plug must be removed from the receptacle before cleaning or maintaining the Docking Station.
  24. Remove the Appliance from the Docking Station, and turn OFF the power switch to the Appliance before removing the battery for disposal of the Appliance.
  25. The battery must be removed and discarded according to local laws and regulations before disposal of the Appliance.
  26. Please dispose of used batteries according to local laws and regulations.
  27. Do not incinerate the Appliance even if it is severely damaged. The batteries can explode in a fire.
  28. When not using the Docking Station for a long period of time, please unplug it.
  29. The Appliance must be used in accordance with the directions in this Instruction Manual. ECOVACS ROBOTICS cannot be held liable or responsible for any damages or injuries caused by improper use.
  30. Prevent unintentional starting. Ensure the switch is in the off position before connecting to battery pack, picking up or carrying the appliance. Carrying the appliance with your finger on the switch or energizing appliance that have the switch on invites accidents.
  31. When battery pack is not in use, keep it away from other metal objects, like paper clips, coins, keys, nails, screws or other small metal objects, that can make a connection from one terminal to another. Shorting the battery terminals together may cause burns or a fire.
  32. Under abusive conditions, liquid may be ejected from the battery; avoid contact. If contact accidentally occurs, flush with water. If liquid contacts eyes, additionally seek medical help. Liquid ejected from the battery may cause irritation or burns.
  33. Do not use a battery pack or appliance that is damaged or modified. Damaged or modified batteries may exhibit unpredictable behavior resulting in fire, explosion or risk of injury.
  34. Do not expose a battery pack or appliance to fire or excessive temperature. Exposure to

fire or temperature above 130°C may cause explosion. The temperature of 130°C can be replaced by the temperature of 265°F.

35. Follow all charging instructions and do not charge the battery pack or appliance outside of the temperature range specified in the instructions. Charging improperly or at temperatures outside of the specified range may damage the battery and increase the risk of fire.
36. Have servicing performed by a qualified repair person using only identical replacement parts. This will ensure that the safety of the product is maintained.
37. Do not modify or attempt to repair the appliance or the battery pack (as applicable) except as indicated in the instructions for use and care.
38. Place the cords from other appliances out of the area to be cleaned.
39. Do not operate the vacuum in a room that has lit candles on furniture that the vacuum may accidentally hit or bump into.
40. Do not allow children to sit on the vacuum.
41. Use only as described in this manual. Use only manufacturer's recommended attachments.
42. Recharge only with the charger specified by the manufacturer. A charger that is suitable for one type of battery pack may create a risk of fire when used with another battery pack.
43. Use appliances only with specifically designated battery packs. Use of any other battery packs may create a risk of injury and fire.
44. The robot contains batteries that are only replaceable by skilled persons. To replace the robot's battery, please contact Customer Service.
45. If the robot will not be used for a long time, fully charge the robot and power OFF for storage and unplug the Docking Station.
46. To Reduce The Risk Of Electric Shock – Do not use on wet surfaces. Do not expose to rain. Store indoors.
47. To Reduce The Risk Of Injury From Moving Parts – Unplug Before Servicing.
48. Risk Of Injury. Brush May Start Unexpectedly. Unplug Before Cleaning or Servicing.
49. To reduce the risk of injury, user must read instruction manual.

## 50. To Reduce The Risk Of Electric Shock – Do not use outdoors or on wet surfaces.

	<b>Direct current</b>
	<b>Alternating current</b>

This Device Complies with DHHS Radiation Rules, 21CFR Chapter 1, Subchapter J.

### Federal Communications Commission (FCC) Interference Statement

This equipment has been tested and found to comply with the limits for a Class B digital device, pursuant to Part 15 of the FCC Rules.

These limits are designed to provide reasonable protection against harmful interference in a residential installation. This equipment generate, uses and can radiate radio frequency energy and, if not installed and used in accordance with the instructions, may cause harmful interference to radio communications.

However, there is no guarantee that interference will not occur in a particular installation. If this equipment does cause harmful interference to radio or television reception, which can be determined by turning the equipment off and on, the user is encouraged to try to correct the interference by one of the following

measures:

- Reorient or relocate the receiving antenna.
- Increase the separation between the equipment and receiver.
- Connect the equipment into an outlet on a circuit different from that to which the receiver is connected.
- Consult the dealer or an experienced radio/TV technician for help.

This device complies with Part 15 of the FCC Rules. Operation is subject to the following two conditions:  
(1) This device may not cause harmful interference, and  
(2) this device must accept any interference received, including interference that may cause undesired operation.

FCC Caution: Any changes or modifications not expressly approved by the party responsible for compliance could void the user's authority to operate this equipment.

This device contains licence-exempt transmitter(s)/ receiver(s) that comply with Innovation, Science and Economic Development Canada's licence-exempt RSS(s). Operation is subject to the following two conditions:

- (1) This device may not cause interference.
- (2) This device must accept any interference, including interference that may cause undesired operation of the device.

## RF exposure warning

This equipment complies with FCC radiation exposure limits set forth for an uncontrolled environment.

This equipment must be installed and operated in accordance with provided instructions and the antenna(s) used for this transmitter must be installed to provide a separation distance of at least 20 cm from all persons and must not be collocated or operating in conjunction with any other antenna or transmitter.

MPE caution (for mobile device under Part 15.247 & 15.407 device)

To satisfy FCC&ICRF exposure requirements, a separation distance of 20cm or more should be maintained between the antenna of this device and persons during device operation.

To ensure compliance, operations at closer than this distance is not recommended.

To disable Wi-Fi module on DEEBOT, power the robot ON. Place the robot on the Docking Station making sure the Charging Contacts on DEEBOT and the Docking Station Pins make a connection.

Press and hold the AUTO Mode Button on the robot for 20 seconds until DEEBOT emits 3 beeps.

To enable Wi-Fi module on DEEBOT, power the robot OFF and then power ON. The Wi- Fi module is turned

on when DEEBOT is restarted.

Air Freshener Capsule(Cucumber&Oak)  
See manufacturing date, expiration date, and lot number on pack.

\*Each unit will last up to 60 days based on 1 hour of use per day on ambient temperature conditions.



### **WARNING:**

May cause an allergic skin reaction.

# Package Contents

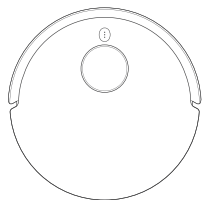

Robot

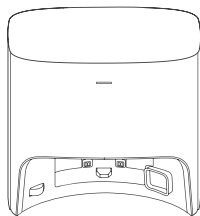

Dust Container

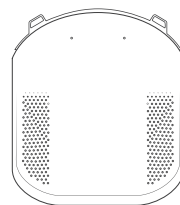

Base

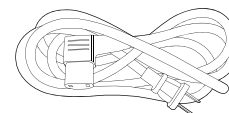

Power Cord



Dust Bag  
(Pre-installed)



Instruction Manual

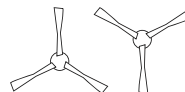

Dual Side Brushes



OZMO™ Pro 3.0  
Oscillating Mopping System

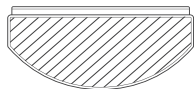

Washable Mopping  
Pad (Pre-installed)



Disposable Mopping  
Pads

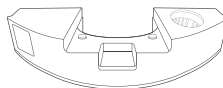

Air Freshener  
(Pre-installed)



Air Freshener Capsule



Multi-Function  
Cleaning Tool

**Note:** Figures and illustrations are for reference only and may differ from actual product appearance. Product design and specifications are subject to changes without notice.

# Product Diagram

## Robot

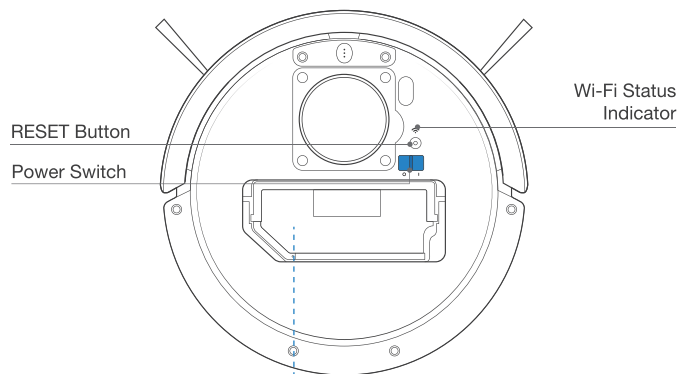
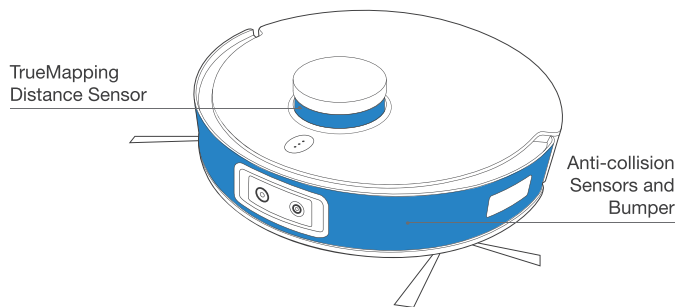
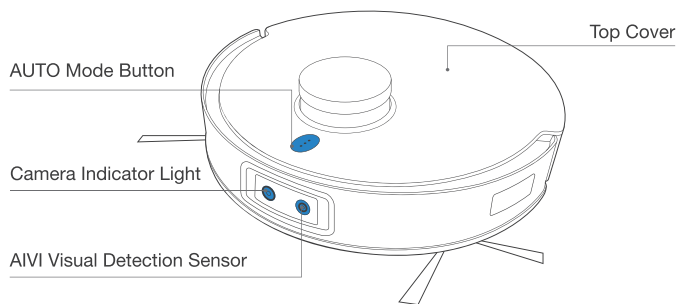

## Auto-Empty Dust Bin

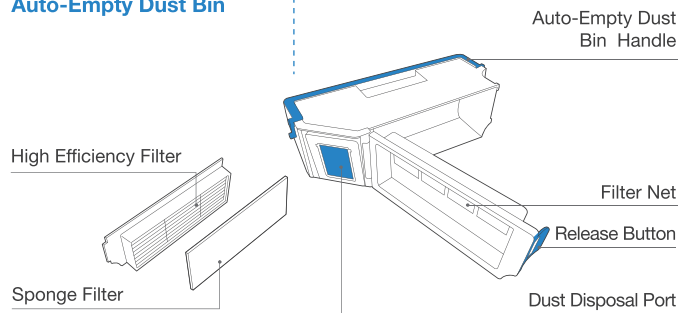

## Bottom View

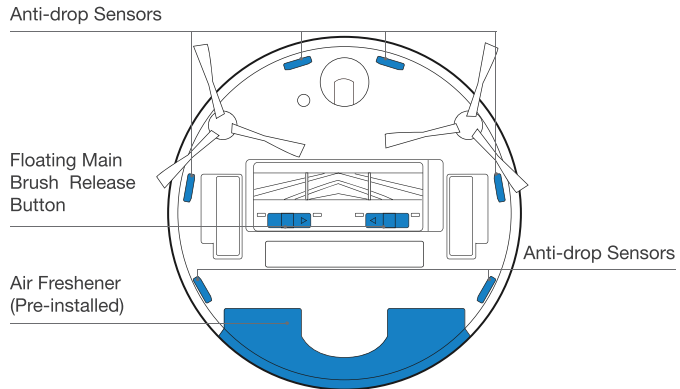
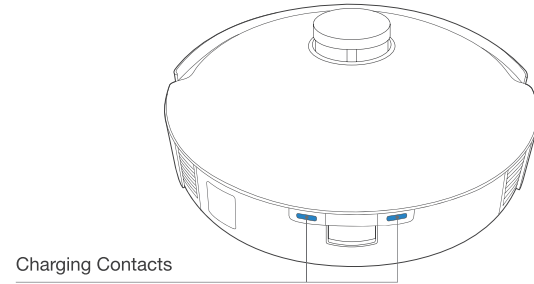
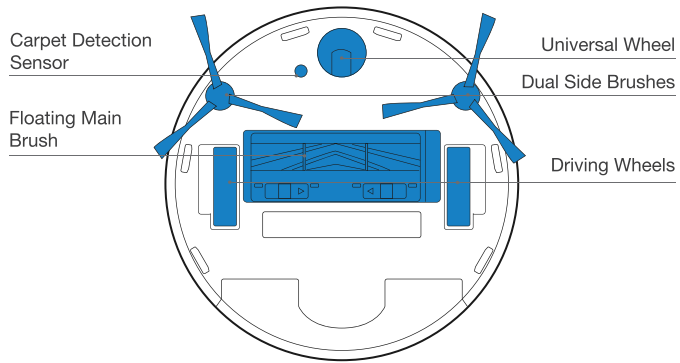

## OZMO™ Pro 3.0 Oscillating Mopping System

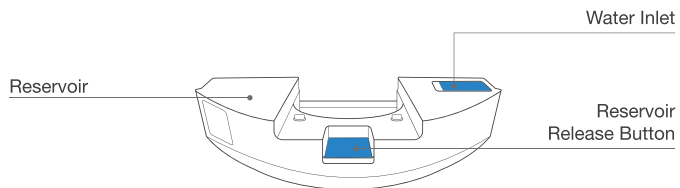

## Air Freshener (Pre-installed)

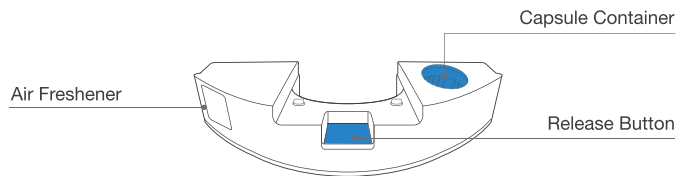

## Empty Station

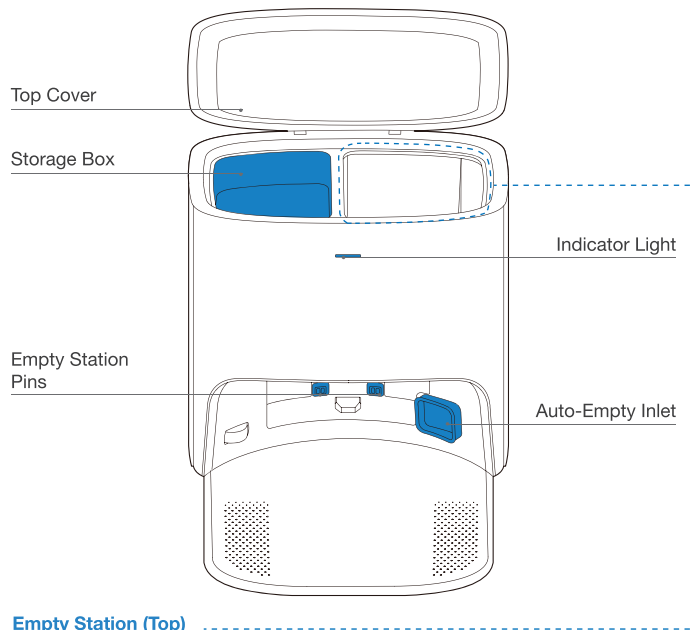

## Empty Station (Top)

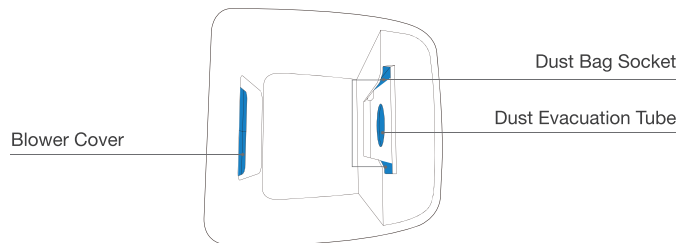

## Empty Station (back)

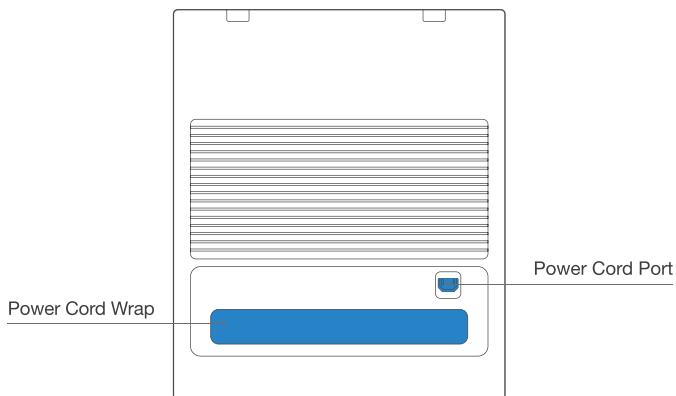

## Dust Bag

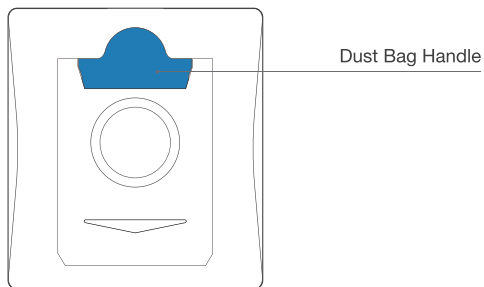

## Notes Before Cleaning

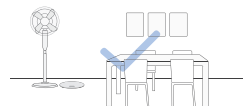

Tidy up the area to be cleaned by putting furniture, such as chairs, in their proper place.



During the first use, make sure each room door is open to help DEEBOT fully explore your house.

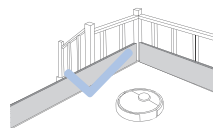

It may be necessary to place a physical barrier at the edge of a drop to stop the unit from falling over the edge.

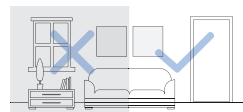

Make sure areas to be cleaned are well illuminated so Visual Detection works properly. Remove power cords and small objects from the floor to ensure cleaning efficiency.



Put away objects including cables, cloths and slippers, etc. on the floor to improve the cleaning efficiency.



Clean the AVI Visual Detection Sensor and TrueMapping Distance Sensor with a clean cloth, and avoid using any detergent or cleaning spray.



Before using the product on a rug with tasseled edges, please fold the rug edges under.



Please do not stand in narrow spaces, such as hallways, and make sure not to block the Detection Sensor.

## Quick Start

Before using DEEBOT, please remove all protective films or protective strips on DEEBOT and Empty Station.

### Install the Dual Side Brushes

Make sure the color of Dual Side Brushes are consistent with that of mounting slot.

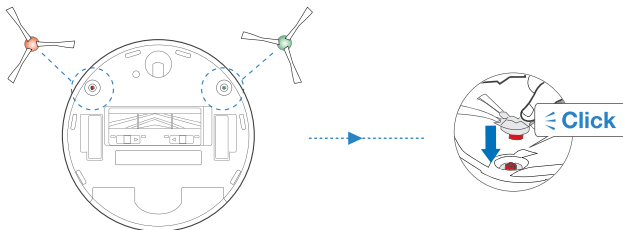

## ECOVACS HOME App

To enjoy all available features, it is recommended to control your DEEBOT via the ECOVACS HOME app.

### Before you start, make sure that:

- Your mobile phone is connected to a Wi-Fi network.
- The 2.4GHz band wireless signal is enabled on your router.
- The Wi-Fi indicator light on DEEBOT is slowly flashing.



### Wi-Fi Indicator Light

	Slowly flashing	Disconnected to Wi-Fi or waiting for Wi-Fi connection
	Rapidly flashing	Connecting to Wi-Fi
	Solid	Connected to Wi-Fi

## Wi-Fi Connection

Before Wi-Fi setup, make sure DEEBOT, mobile phone, and Wi-Fi network meet the following requirements.

### DEEBOT and Mobile Phone Requirements

- DEEBOT is fully charged and the power switch of DEEBOT is turned on.
- Wi-Fi status light slowly flashes.
- Turn off mobile phone's cellular data (you can turn it back on after setup).

### Wi-Fi Network Requirements

- You are using a 2.4GHz or 2.4/5 GHz mixed network.
- Your router supports 802.11b/g/n and IPv4 protocol.
- Do not use a VPN (Virtual Private Network) or Proxy Server.
- Do not use a hidden network.
- WPA and WPA2 using TKIP, PSK, AES/CCMP encryption.
- WEP EAP (Enterprise Authentication Protocol) is not supported.
- Use Wi-Fi channels 1-11 in North America and channels 1-13 outside North America (refer to local regulatory agency).
- If you are using a network extender/repeater, the network name (SSID) and password are the same as your primary network.

Please be aware that the realization of intelligent functions such as remote startup, 2D/3D map display and control settings, and personalized cleaning (depending on different products) requires users to download and use ECOVACS HOME App, which is constantly updated. You need to agree to our Privacy Policy and User Agreement before we can process some of your basic and necessary information and enable you to operate the product. If you do not agree with our Privacy Policy and User Agreement, some of the aforementioned intelligent functions cannot be realized through ECOVACS HOME App, but you can still use the basic functions of this product for manual operation.

# Charging DEEBOT

## 1 Connect the Power Cord

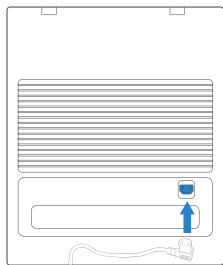

## 2 Empty Station Placement and Assembly

**Note:** Please do not place the Empty Station on the carpet. Keep the area around the Station clear of objects and reflective object surfaces.

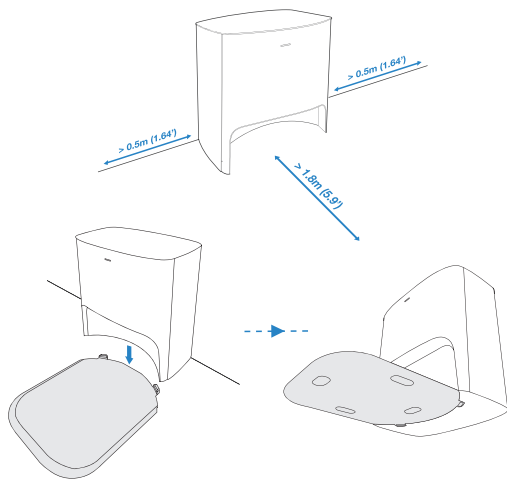

## 3 Power ON

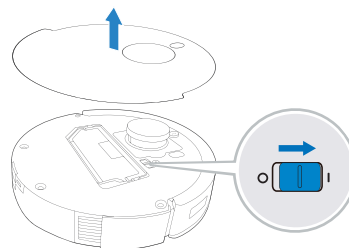

**Note:** I = ON, O = OFF.

DEEBOT cannot be charged when being powered OFF.

## 4 Charge DEEBOT

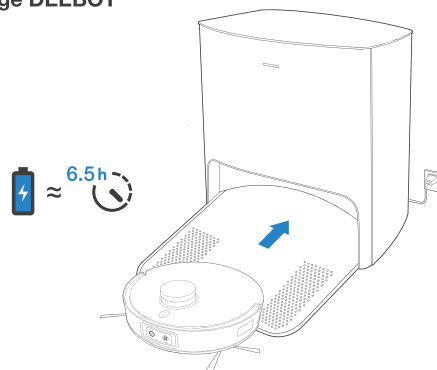

It is recommended that DEEBOT start cleaning from the Station. Do not move the Station while cleaning. When cleaning is complete, it is recommended to remove the Mopping Pad and manually place DEEBOT into the Station.

# Operating DEEBOT

For the first-time cleaning, please ensure that DEEBOT is fully charged.

**During the first cleaning:**

1. Please make sure to install Air Freshener to create a home map in ECOVACS HOME App
2. Please ensure that DEEBOT is fully charged.
3. Please supervise DEEBOT and assist it should there be a problem.

## 1 Start

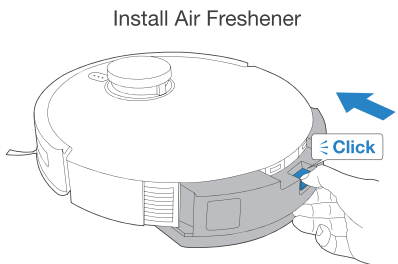

Tap 

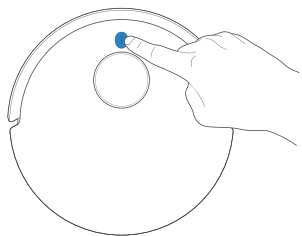

## 2 Pause/Wake Up

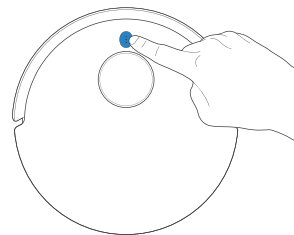

**Note:** The robot's Control Panel stops glowing after the robot is paused for a few minutes. Tap the AUTO Mode Button on DEEBOT to wake up the robot.

## 3 Return to Charge

Tap  for 3 seconds to send DEEBOT back to the Empty Station.

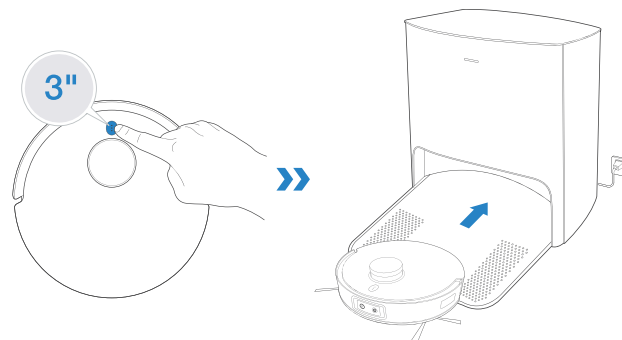

# OZMO™ Pro 3.0 Oscillating Mopping System

## Note:

1. Install OZMO™ Pro 3.0 Oscillating Mopping System for floor scrubbing.
2. Before installing OZMO™ Pro 3.0 Oscillating Mopping System, please make sure the contacts are thoroughly dry.
3. Please avoid using OZMO™ Pro 3.0 Oscillating Mopping System on the carpet.
4. It is recommended to drench and wring out the Mopping Pad before installing it to have a better cleaning.

## 1 Add Water

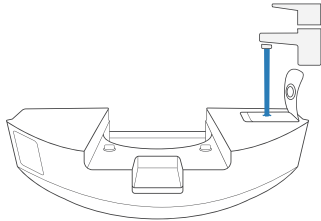

- \* To prolong the service life of OZMO™ Pro 3.0 Oscillating Mopping System, it is recommended to use purified water or softened water.
- \* Do not soak OZMO™ Pro 3.0 Oscillating Mopping System in water.

## 2 Dry Contacts Thoroughly

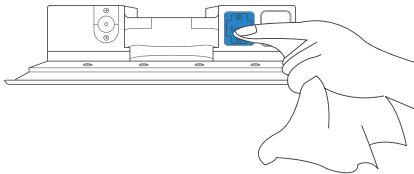

## 3 Install OZMO™ Pro 3.0 Oscillating Mopping System

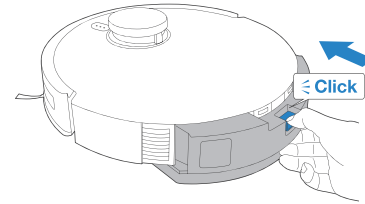

## 4 Start Cleaning

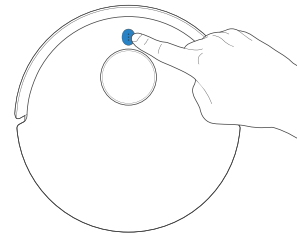

# Air Freshener

## 1 Install Air Freshener Capsule

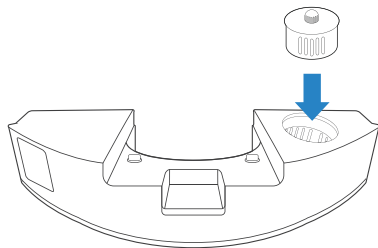

## 2 Install Air Freshener

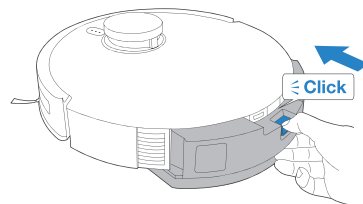

# Regular Maintenance

To keep DEEBOT running at peak performance, perform maintenance tasks and replace parts with the following frequencies:

Robot Part	Maintenance Frequency	Replacement Frequency
Air Freshener Capsule	/	Every 2 months
Washable Mopping Pad	/	Every 1-2 months
Disposable Mopping Pad	After each use	Replace after each use
Dust Bag	/	Replace when voice prompts
Dual Side Brushes	Once every 2 weeks	Every 3-6 months
Floating Main Brush	Once per week	Every 6-12 months
Sponge Filter/High Efficiency Filter	Once per week	Every 3-6 months
AIVI Visual Detection Sensor TrueMapping Distance Sensor Universal Wheel Anti-Drop Sensors Bumper Charging Contacts Empty Station Pins	Once per week	/
Auto-Empty Dust Bin	Once per month	/
Empty Station	Once per month	/

**Before performing cleaning and maintenance tasks on DEEBOT, turn the robot OFF and unplug the Empty Station.**

**A multi-function Cleaning Tool is provided for easy maintenance. Handle with care, this cleaning tool has sharp edges.**

**Note:** ECOVACS manufactures various replacement parts and fittings. Please contact Customer Service for more information on replacement parts.

# Maintain OZMO™ Pro 3.0 Oscillating Mopping System

## 1 Remove OZMO™ Pro 3.0 Oscillating Mopping System

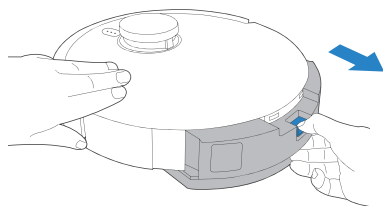

\* After DEEBOT finishes mopping, please empty the reservoir.

## 2 Wipe OZMO™ Pro 3.0 Oscillating Mopping System Clean

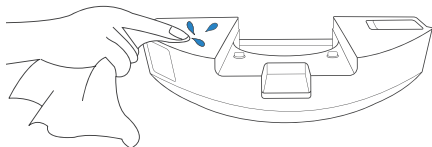

\* Wipe OZMO™ Pro 3.0 Oscillating Mopping System with a clean, dry cloth. Do not soak into water.

## 3 Washable Mopping Pad

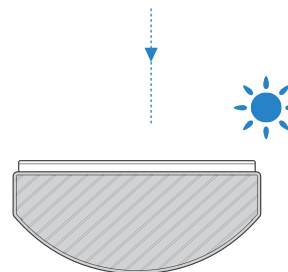
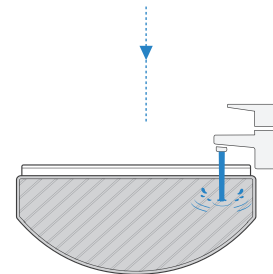
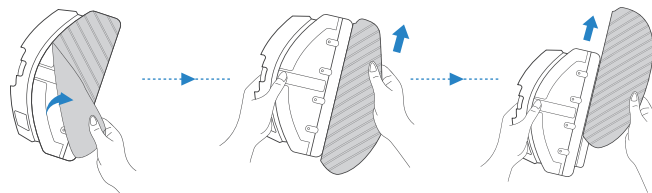

#### 4 Disposable Mopping Pad

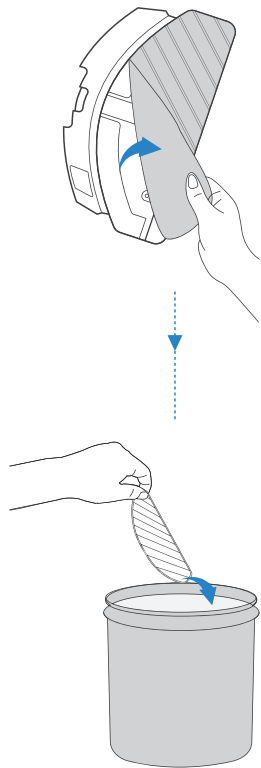

### Maintain Auto-Empty Dust Bin and Filters

1

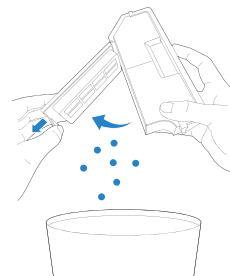

2

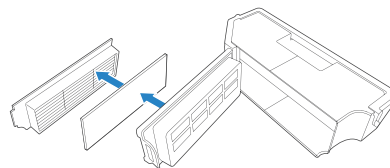

3

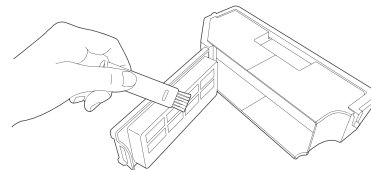

4

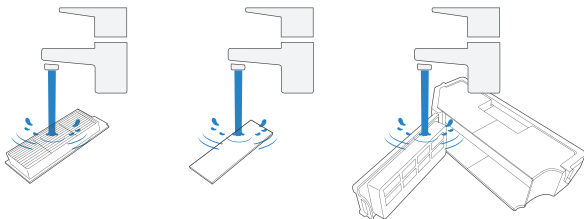

**Note:**

1. Please rinse the filter with water as shown above.
2. Do not use finger or brush to clean the filter.

5

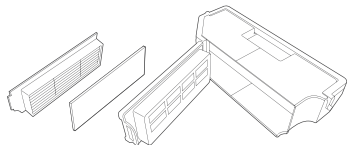

## Maintain Floating Main Brush and Dual Side Brushes

### Floating Main Brush

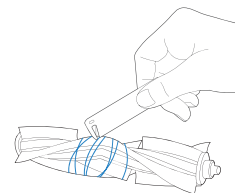
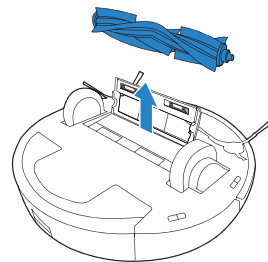
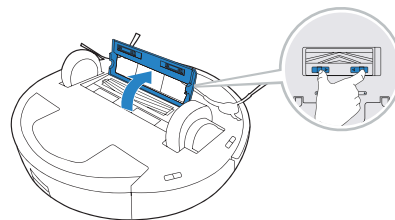

## Dual Side Brushes

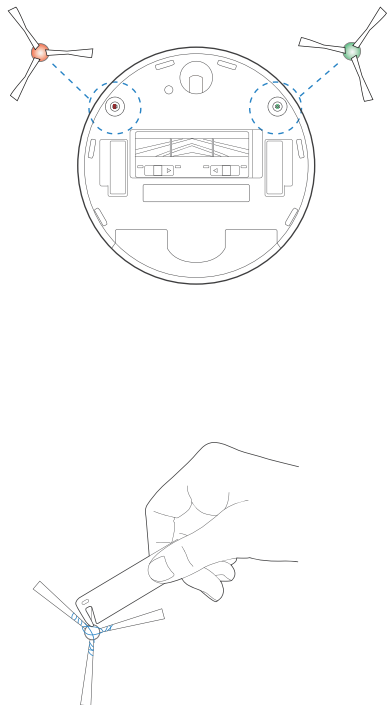

## Maintain Empty Station

**Note:** Before performing cleaning and maintenance on Empty Station, unplug it first.

\* For a proper maintenance, wipe with a clean dry cloth, and avoid using any detergent or cleaning spray.

### Empty Station Pins

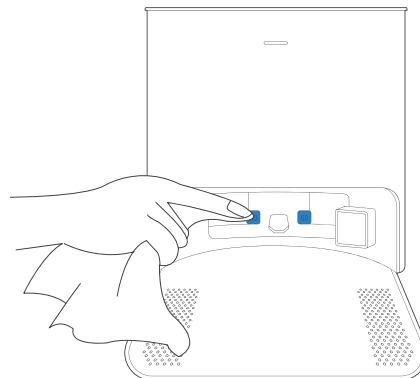

## Dust Bag

### 1 Dispose the Dust Bag

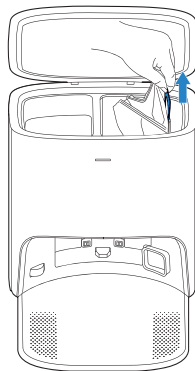
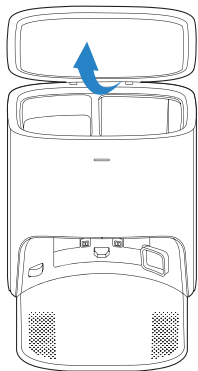

\* Hold the Handle to lift out the Dust Bag, which can effectively prevent dust leakage.

### 2 Clean the Blower Cover

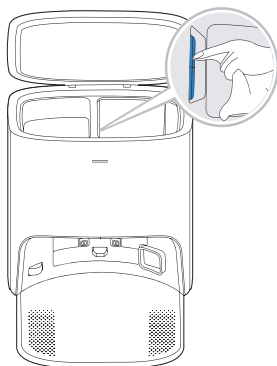

### 3 Install the Dust Bag

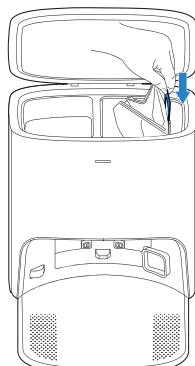

### 4 Close the Dust Container Lid

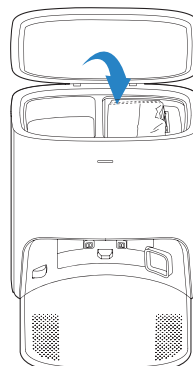

## Maintain Other Components

**Note:** Wipe the components with a clean, dry cloth. Avoid using cleaning sprays or detergents.

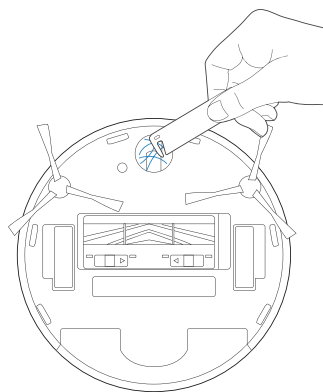
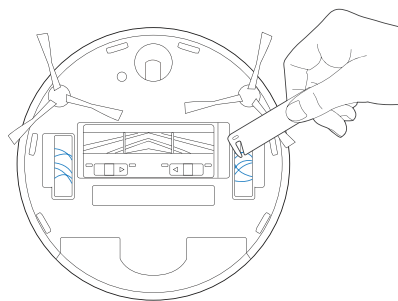
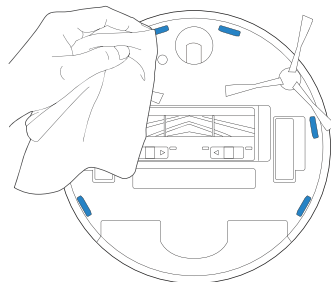
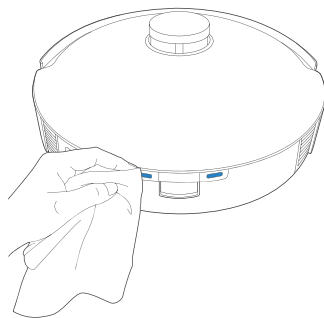
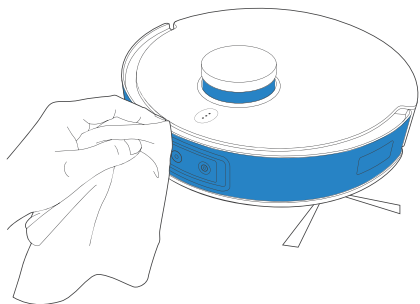

## Empty Station

The light effect of the Status Indicator on Empty Station corresponds to different conditions and solutions. For more support, please refer to ECOVACS HOME App or the Troubleshooting Section of this manual.

Light Effect	Status	Solutions
Indicator light off	The Empty Station is in standby.	/
	DEEBOT is in Do Not Disturb Mode.	/
Glowing a solid WHITE	DEEBOT returns to the Empty Station and starts to Auto-Empty.	/
	DEEBOT is Auto-Emptying.	/
	DEEBOT pairs successfully with the Empty Station.	/
Glowing a solid RED	The Dust Bag is not installed.	Please install the Dust Bag.
	The Empty Station's suction power decreased.	Please check the Dust Bag.
	The Empty Station failed to Auto-Empty the dust.	Please check the solution in the App.
	The Dust Container Lid is not closed.	Please make sure the Dust Container Lid is firmly closed.

# Troubleshooting

No.	Malfunction	Possible Causes	Solutions
1	DEEBOT is not able to connect to ECOVACS HOME App.	Incorrect home Wi-Fi username or password entered.	Enter the correct home Wi-Fi username and password.
		DEEBOT is not within range of your home Wi-Fi signal.	Make sure DEEBOT is within range of your home Wi-Fi signal.
		DEEBOT is not in the configuration state.	Make sure DEEBOT is connected to the power supply and turned on. Open the cover, and press RESET Button. DEEBOT will enter the configuration state when you hear a voice prompt.
		Incorrect App installed.	Please download and install ECOVACS HOME App.
		Not using a 2.4GHz or 2.4/5 GHz mixed network.	DEEBOT does not support 5G network. Please use a 2.4GHz or 2.4/5 GHz mixed network.
2	Unable to create furniture map on App.	DEEBOT does not start cleaning from the Station.	DEEBOT must start cleaning from the Station.
		Move DEEBOT when cleaning might cause the mop lost.	During cleaning, do not move DEEBOT as far as possible.
		Auto cleaning is not complete.	Make sure DEEBOT automatically return to the Station after cleaning.
3	DEEBOT Dual Side Brushes drop out of place during use.	The Dual Side Brushes are not correctly installed.	Make sure the Dual Side Brushes click into place when installing.
4	No signal found. Unable to return to the Station.	The Station is incorrectly placed.	Please place the Station correctly according to the instructions in the <a href="#">[Charging DEEBOT]</a> section.
		The Station is out of power or manually moved.	Check whether the Station is connected to power supply. Do not move the Station.
		DEEBOT does not start cleaning from the Station.	It is recommended that DEEBOT start cleaning from the Station.
		The charging route is blocked. For example, the door of the room with the Station is closed.	Keep the charging route clear.

No.	Malfunction	Possible Causes	Solutions
5	DEEBOT returns to the Station before it has finished cleaning.	The room is large and DEEBOT needs to return to recharge.	Please turn on Continuous Cleaning. For more details, please follow the App guidance.
		DEEBOT is unable to reach certain areas blocked by furniture or barriers.	Tidy up the area to be cleaned by putting furniture and small objects in their proper place.
6	DEEBOT is not charging.	DEEBOT is not switched ON.	Switch ON DEEBOT.
		DEEBOT's Charging Contacts are not connected to the Station Pins.	Make sure that the robot's Charging Contacts have connected to the Station Pins and the AUTO Mode Button flashes. Check whether DEEBOT'S Charging Contacts and the Station are dirty. Please clean these parts according to the instructions in the <a href="#">[Maintenance]</a> section.
		The Station is not connected to the power supply.	Make sure the Power Cord is firmly connected to the Station.
		The battery is completely discharged.	Please contact Customer Care for help.
7	Running is very loud during cleaning.	Dual Side Brushes and Floating Main Brush are entangled. Auto-Empty Dust Bin and filter are blocked.	It is recommended to clean the Dual Side Brushes, Floating Main Brush , Auto-Empty Dust Bin , filter, etc. regularly.
		DEEBOT is in Strong Mode.	Switch to Standard Mode.
8	DEEBOT gets stuck while working and stops.	DEEBOT is tangled with something on the floor (electrical wires, curtains, carpet fringing, etc.).	DEEBOT will try various ways to free itself. If it is unsuccessful, manually remove the obstacles and restart.
		DEEBOT might be stuck under furniture with an entrance of similar height.	Please set a physical barrier, or set a Virtual Boundary in the ECOVACS HOME App.

No.	Malfunction	Possible Causes	Solutions
9	During cleaning, DEEBOT appears in the route disorder, running bias, repeated cleaning, small area leakage and so on. (If there is a large area that has not been swept temporarily, DEEBOT will make up the leakage independently. Sometimes DEEBOT will re-enter a cleaned room to find any missing area.)	Objects such as wires and slippers placed on the ground affect the normal operation of DEEBOT.	Please tidy up the scattered wires, slippers and other objects on the ground before cleaning. And reduce the scattered objects on the ground as far as possible. If there is any area leakage, DEEBOT will correct the leakage by itself, please do not interfere (such as moving DEEBOT or blocking the route).
		It may be that the Driving Wheels slips on the ground when DEEBOT climbs steps, thresholds and door bars, thus affecting the its judgment of the whole house environment.	It is recommended to close the door of this area and clean the area separately. After cleaning, DEEBOT will return to the starting point. Please rest assured to use.
		Work on freshly waxed and polished floors or smooth tiles, resulting in less friction between the Driving Wheels and the floor.	Please wait for wax to dry before cleaning.
		Due to different home environments, some areas cannot be cleaned.	Clean the home environment to ensure that DEEBOT can enter for cleaning.
		The TrueMapping Distance Sensor is dirty or blocked by foreign matters.	Wipe the TrueMapping Distance Sensor with a clean soft cloth or remove foreign matters.
10	Video Manager cannot open or has no screen.	Wi-fi connection failed.	Check the Wi-Fi connection status. DEEBOT must be in an area with good Wi-Fi signal to enable the Video Manager.
		Due to the network latency, you may not be able to open Video Manager temporarily.	Try again later.
		The AIVI Visual Detection Sensor is blocked.	Remove the shield.
11	Delay in remote control.	The Wi-Fi signal is poor, causing the video loading to be slow.	Use DEEBOT in areas with good Wi-Fi signals.
12	AIVI Visual Detection Sensor cannot recognize objects.	The cleaning area is not well illuminated.	Smart Recognition requires sufficient lighting. Please make sure the areas to be cleaned are well illuminated.
		AIVI Visual Detection Sensor lens is dirty or blocked.	Clean the lens with a clean soft cloth, and make sure the sensor is not blocked. Avoid using any detergent or cleaning spray while cleaning.

No.	Malfunction	Possible Causes	Solutions
13	DEEBOT does not start auto-emptying after returning to the Empty Station.	The Dust Container Lid is not closed.	Close the Dust Container Lid.
		The Dust Bag is not installed to the Empty Station.	Install the Dust Bag and close the Dust Container Lid.
		Manually move DEEBOT to the Empty Station will not trigger Auto-Emptying.	In order to make sure DEEBOT starts auto-emptying successfully, avoid picking up and moving the Empty Station during the cleaning.
		DEEBOT returns to the Auto-Emptying Station running Video Manager in the App.	This is normal.
		Do Not Disturb mode is enabled in ECOVACS HOME App.	This is normal. Disable Do Not Disturb mode in the App, or start auto-emptying manually.
		The Dust Bag is full.	Replace the Dust Bag and close the Dust Container Lid.
		If the possible causes are excluded, it might be a component malfunction.	Please contact customer service.
14	DEEBOT fails to auto-empty the Auto-Empty Dust Bin .	The Auto-Empty Dust Bin is not installed.	Please install the Auto-Empty Dust Bin .
		The Dust Bag is full.	Replace the Dust Bag and close the Dust Container Lid.
		The Dust Disposal Port on the Auto-Empty Dust Bin is stuck by debris.	Uninstall the Auto-Empty Dust Bin and clean the debris on the Dust Disposal Port.
		Dust Evacuation Tube is blocked.	Clean the Dust Evacuation Tube.
15	There is debris in the Dust Container.	Fine particles are absorbed inside the Dust Container through the Dust Bag.	Clean the Dust Container Lid and inner wall.
		The Dust Bag is damaged.	Check the Dust Bag and replace it.
16	DEEBOT leaks dust or debris while cleaning.	The Dust Disposal Port are stuck by debris.	Uninstall the Auto-Empty Dust Bin and clear the debris.

No.	Malfunction	Possible Causes	Solutions
17	Air Freshener makes an abnormal noise.	Objects have fallen into the Air Freshener.	Please contact Customer Service for assistance.
18	DEEBOT does not respond to the Station instruction.	DEEBOT is too far away from the Station.	If it is beyond the available distance, the ECOVACS HOME App can also be used to operate DEEBOT.
		DEEBOT and the Station are not paired.	Unplug the Station plug and wait for 10 seconds to reinsert the plug. Manually push the robot up to the Station, and ensure that the charging pins are correctly connected. Then, DEEBOT will start charging, and voice prompt pairing successful.
19	Driving wheels are blocked.	Driving wheels are blocked by foreign objects.	Please rotate and press the driving wheels to check whether there is any foreign object wrapped or stuck. If there is any foreign object, please clean it in time. If this problem persists, please contact Customer Care for help.
20	DEEBOT OZMO™ Pro 3.0 Oscillating Mopping System drops out of the place during use.	The OZMO™ Pro 3.0 Oscillating Mopping System is not correctly installed.	Make DEEBOT OZMO™ Pro 3.0 Oscillating Mopping System clicks into place when installing.
21	DEEBOT is stuck when cleaning with OZMO™ Pro 3.0 Oscillating Mopping System installed.	DEEBOT may have difficulty climbing over obstacles when using OZMO™ Pro 3.0 Oscillating Mopping System.	Please assist DEEBOT if there is a problem.

## Technical Specifications

<b>Model</b>	<b>DBX33</b>
Rated Input	20V === 1A
<b>Empty Station Model</b>	<b>CH2117</b>
Rated Input	100-120V ~ 50-60Hz 6.0-6.8A (Auto-Emptying) 0.4A(Charging)
Rated Output	20V === 1A

Output power of the Wi-Fi module is less than 100mW.

**Note:** Technical and design specifications may be changed for continuous product improvement.

Explore more accessories at <https://www.ecovacs.com/global>.



**Ecovacs Robotics Co., Ltd.**

No.518 Songwei Road, Wusongjiang Industry Park, Guoxiang Street,  
Wuzhong District, Suzhou, Jiangsu, China.