



User Manual

Model: H6098B

Govee Smart TV Backlight 3S

Safety Instructions

Read and follow all the safety instructions:

- Be cautious of static electricity during installation and usage. Keep the product away from sharp objects or strong corrosive chemicals.
- When bending the strip light during installation, avoid folding the LED components as it may affect the product's lifespan.
- Remove nails, metal, or other conductive objects from the installation surface before attaching the strip light, as it may cause short-circuiting.
- Do not install the strip light near any heat sources.
- Do not allow children to install the strip light alone.
- Avoid installing the strip light near potentially dangerous sources (e.g., candles, liquid-filled objects).
- CAUTION-The product is not a toy. Children and the disabled should use it under adult supervision.

Introduction

Thank you for choosing the Govee Smart TV Backlight 3S. This TV strip light provides an immersive viewing experience. The camera positioned in the top center of your TV can intelligently capture the colors displayed and automatically apply them to your lights. It significantly enriches your gaming worlds and movie nights.

What You Get

LED Strip Light	1
Adapter	1
Control Box	1
Camera	1
User Manual	1

At a Glance

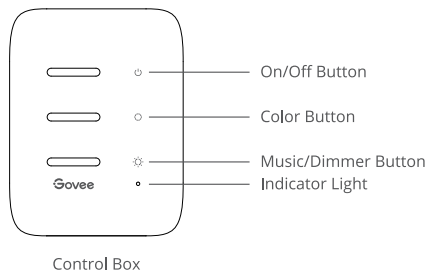

On/Off Button	Press to turn on/off.
Color Button	Press to adjust the color.
Music/Dimmer Button	Press to enter Music Mode. Long press to adjust the brightness.
Indicator Light	a. A red light indicates the device is not connected to the network. b. A blue light indicates the device has successfully connected to the network. c. No light indicates the device is not powered on or malfunctioning.

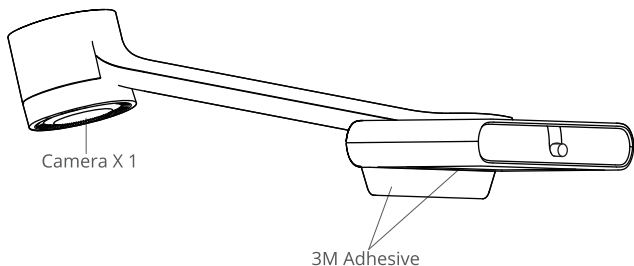

Installing Your Device

1 Preparation Before Installing:

- Unbox the strip light and check all items listed in the packing list.
- Power on the strip light and check whether it lights up.

2 Installing Steps:

- Wipe the installation surface to ensure it is dry and clean.

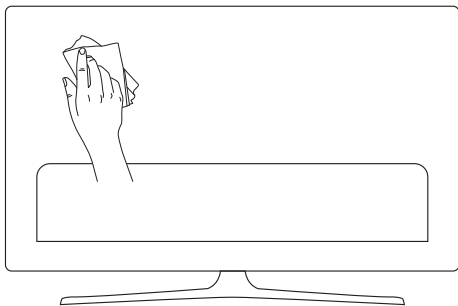

- Stick the strip light to the back of the TV. Press it firmly and then reinforce it with the provided clips.

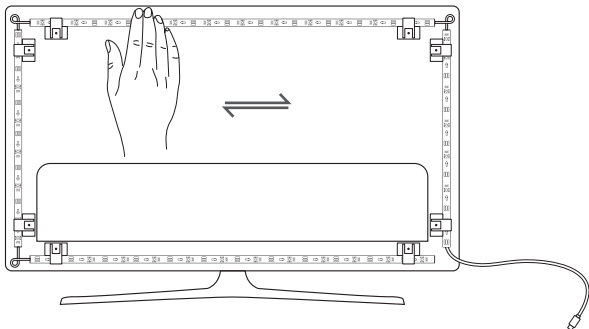

- c. Position the camera to the top center of the TV.
Tip: If you have an ultra-thin TV, stick the black foam sticker on the back of the monitor to help fix the camera.

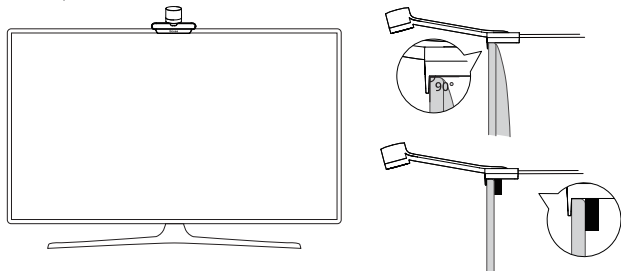

- d. Insert the cable of the strip light and the camera into the control box. (Type-C/DC)

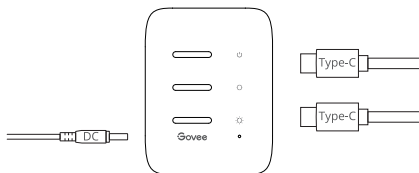

- e. Ensure that the control box is in a proper position near your TV.
f. Power on the strip light and try connecting it with Govee Home App.

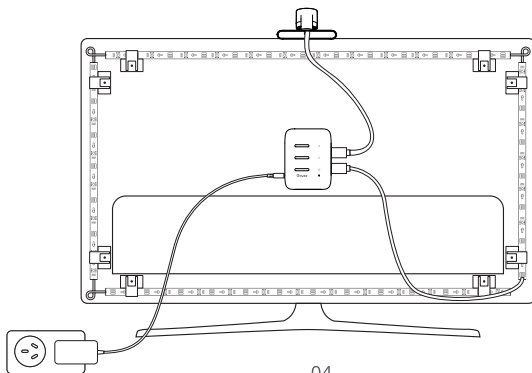

Pairing Your Device with Govee Home App

What you need:

- A Wi-Fi router supporting the 2.4GHz and 802.11 b/g/n bands. 5GHz is not supported.
- 1 Download Govee Home App from the App Store (iOS devices) or Google Play (Android devices).



- 2 Turn on your smartphone's Bluetooth.
- 3 Open the app, tap the "+" icon in the top right corner and search "H6098."
- 4 Tap the device icon and follow the on-screen instructions to complete pairing.

Calibrating the Camera with Govee Home App

- 1 Mount the camera to the center of the screen.

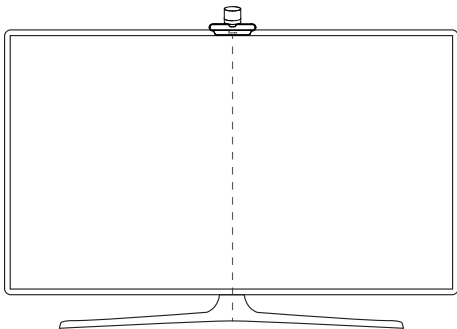

- 2 Stick the foam stickers to the 7 calibration points on the screen.

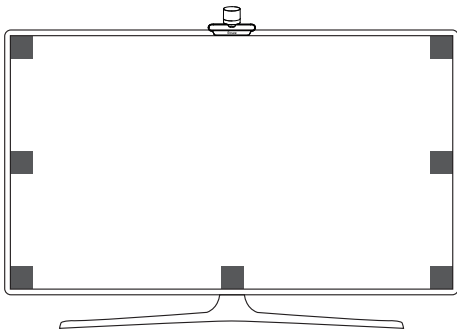

- 3 Open Govee Home App, go to the details page, then tap Calibration. Begin the calibration by following the instructions.

Tips:

- a. Drag the seven calibration points to the position points.

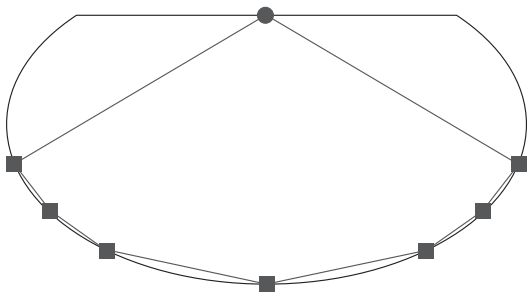

● Camera ■ Position Points

- b. The picture will distort under the fish-eye camera. Make sure the calibration points are chosen correctly and the calibration line do not overlap or cross each other or drag the line outside the screen. After that, the chip will automatically calibrate the fish-eye picture and capture the colors.

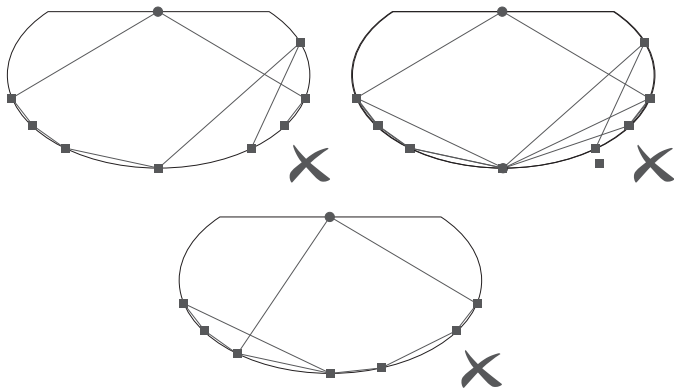

Controlling the Device with Your Voice

- ① Open the app, then tap the device icon to enter the details page.
- ② Tap the settings icon in the top right corner.
- ③ Select User Guide and follow the on-screen instructions to control the device using your voice.

Specifications

Power Input (Adapter)	AC 100-240V(US Plug)
	AC 200-240V(EU&BS Plug)
Power Input (Control Box)	12VDC 2A (55-65inch)
Length	1.96ft (left/right)+3.93ft (top/bottom)
Light Displaying Technology	RGBICW
Camera Model	H6098A

Troubleshooting

- 1 The strip light does not light up.
 - Check all wired connections. Unplug and replug the power adapter and the DC port to ensure the control box powers on correctly. The strip light will light up 10s after being powered on.
 - Check the wired connections for the strip light and the camera.
 - If you unplugged the strip light, reboot the power adapter after the light is working correctly.
- 2 Calibration failed.
 - Calibrate the strip light again.
 - Make sure no other strong lights are affecting the camera.
 - Calibration points must be chosen correctly. For example, the top calibration point on your TV cannot be dragged to the bottom. The calibration lines cannot overlap or cross each other.
 - Calibration can only begin after the strip light is successfully connected to Wi-Fi.
- 3 The provided strip light's adhesive don't stick well.
 - Wipe the installation surface to ensure it is dry and clean.
 - When attaching the strip light, make sure you press down firmly.
 - Reinforce the strip light with the provided clips or other strong adhesives.
- 4 Calibration and picture upload failure.
 - With your smartphone, check whether the Wi-Fi connection is stable.
- 5 Wi-Fi connection failure.
 - Do not skip the Wi-Fi connection during setup. Ensure you input the correct Wi-Fi name and password according to the app's instructions.
 - 5GHz Wi-Fi is not supported. Connect the strip light to a 2.4G Wi-Fi band the reboot your router.
 - With your smartphone, check whether the Wi-Fi connection is stable.
 - The strip light is not compatible with the Wi-Fi name or password. Please change the Wi-Fi name and password.
 - The strip light is not compatible with your router. Please try to connect your strip light to a smartphone hotspot.

This product contains a light source of energy efficiency class G.
Colour - tuneable light sources that can be set to at least the colours listed in this point and which have for each of these colours, measured at the dominant wavelength, a minimum excitation purity of:

Blue	462.4nm	96.8%
Green	523.5nm	82.3%
Red	636.7nm	100.0%

and are intended for use in applications requiring high-quality coloured light.

Reference control settings: 4000K, "White Light" in Govee Home App.

Disassembly Tip:

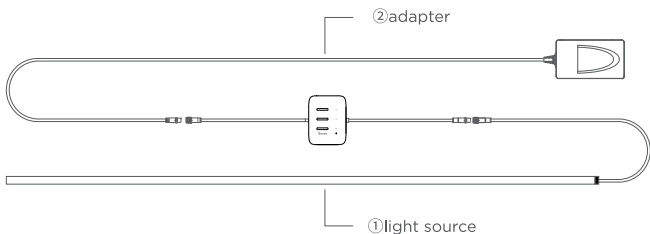

The product is divided into two parts: (1) a light source and (2) an adapter. By detaching the output terminal of the adapter, you can easily remove the light source or the adapter.

Customer Service

 Warranty: 12-Month Limited Warranty

 Support: Lifetime Technical Support

 Email: support@govee.com

 Official Website: www.govee.com

 @Govee  @govee_official  @govee.official

 @Goveeofficial  @Govee.smarthome



Govee Home App

For FAQs and more information,
please visit: www.govee.com