



WINBOT **W2S**

Instruction Manual

Instruction Manual	EN	 P03
Bedienungsanleitung	DE	 P24
Manuel d'instructions	FR	 P46
Manuale d'istruzi	IT	 P68
Manual de instrucciones	ES	 P90
Brugsanvisning	DK	 P112
Käyttöopas	FI	 P133
Bruksanvisning	NO	 P154
Instructiehandleiding	NL	 P175
Podręcznik obsługi	PL	 P197
Naudojimo vadovas	LT	 P219
Priručnik s uputama	HR	 P241
Bruksanvisning	SE	 P263
מדריך הוראות	HE	 P284

For the Instruction Manual in further languages, visit: <https://www.ecovacs.com>.

Für Bedienungsanleitungen in weiteren Sprachen besuchen Sie bitte: <https://www.ecovacs.com>.

Pour les manuels d'instructions dans d'autres langues, veuillez visiter: <https://www.ecovacs.com>.

Per i manuali di istruzioni in altre lingue: <https://www.ecovacs.com>.

Para manuales de instrucciones en otros idiomas, visite: <https://www.ecovacs.com>.

For brugervejledninger på andre sprog, besøg: <https://www.ecovacs.com>.

Käyttöopas on saatavilla muilla kielillä osoitteessa <https://www.ecovacs.com>.

Katso käyttöohjeet muilla kielillä osoitteessa: <https://www.ecovacs.com>.

For bruksanvisninger på flere språk, besøk: <https://www.ecovacs.com>.

Voor handleidingen in andere talen, ga naar: <https://www.ecovacs.com>.

Aby uzyskać instrukcje obsługi w innych językach, odwiedź: <https://www.ecovacs.com>.

Norėdami gauti instrukcijas kitomis kalbomis, apsilankykite: <https://www.ecovacs.com>.

Za upute na drugim jezicima posjetite: <https://www.ecovacs.com>.

För bruksanvisningar på fler språk, besök: <https://www.ecovacs.com>.

תבנתב ורקב, תופסונ תופשב תוארוה יכירדמ תלבקל: <https://www.ecovacs.com>.

Important Safety Instructions

When using an electrical appliance, basic precautions should always be followed, including the following:

READ ALL INSTRUCTIONS BEFORE USING THIS APPLIANCE.

SAVE THESE INSTRUCTIONS

1. This appliance can be used by persons with reduced physical, sensory or mental capabilities or lack of experience and knowledge if they have been given supervision or instruction concerning use of the appliance in a safe way and understand the hazards involved. Children shall not play with the appliance. The appliance is not to be used if it has been dropped, if there are visible signs of damage or if it is leaking. Keep the appliance out of reach of children when it is energized.
2. Do not use and charge the Appliance in extremely hot or cold environments (below 0°C/32°F or above 40°C/104°F, above 85% humidity), or it may affect battery life span.
3. The Appliance can be used to clean exterior windows if it is properly tethered to a safe position with the Carabiner, winds are calm, and it is not raining or snowing.
4. Before use, please use the Carabiner to lock the safety tether to a strong indoor railing, and make sure WINBOT is securely attached to it.
5. Do not leave the Appliance unattended when using it. To prevent bodily injury or property damage caused by accidental falling of the Appliance, please make sure there are no people, animals, or valuable, fragile objects under the working area of WINBOT.
6. Do not use the Appliance in whole gale storms and force-10 winds, or in areas where the altitude exceeds 2000 meters (6562 feet).
7. Please ensure the Appliance is plugged in while it is cleaning. The Appliance has a Safety Battery that charges during use. The Safety Battery powers the Appliance if it becomes unplugged or the electricity fails.
8. Do not leave the Appliance unattended when it is plugged in.
9. For household use ONLY (including exterior window). Do not use the Appliance in commercial or industrial environments.
10. Do not use on broken or uneven glass, such as glass with static cling stickers, advertising posters, or raised patterns, so as to prevent glass breaking or Appliance's falling. Do not







use on surfaces with gaps, such as a piece of glass with gaps or holes, or two pieces of adjacent, frameless glass with a gap between them, so as to prevent the Appliance from falling due to poor attachment.

11. Only use accessories recommended or supplied by the manufacturer. Only use the Power Adapter supplied by the manufacturer.
12. Please make sure your power supply voltage matches the power voltage marked on the Power Adapter.
13. Do not use the Appliance on a framed glass with a frame smaller than 5 mm (0.2 in).
14. Do not use on glass less than 3 mm (0.12 in) thick or mirrors less than 4 mm (0.16 in) thick.
15. Do not use on glass or mirrors with a handle height of 70~105 mm (2.76~ 4.13 in).
16. Do not use the Appliance on greasy windows.
17. When used in high humidity environment, the cleaning performance will be affected.
18. Store the Appliance away from heat and flammable materials.
19. In rainy weather, do not use the Appliance on the exterior window to avoid the risk of Appliance's damage or falling.
20. Do not use the Appliance if it does not firmly attach to the glass or has visible signs of damage.
21. To reduce the risk of electrical shock, do not put the Appliance in water or other liquid. Do not place or store Appliance where it can fall or be pulled into a tub or sink.
22. Do not touch power plug with wet hands.
23. When charging the Appliance, do not place it on other electrical appliances and keep it away from fire and liquid.
24. Take care not to damage the power cord. Do not pull on or carry the Appliance by the power cord, use the power cord as a handle, close a window on the power cord, or put heavy weights on the power cord. Keep power cord away from hot surfaces.
25. Do not use with a damaged power cord or receptacle. Do not use the Appliance if it is not working properly, has been dropped, damaged, or come in contact with water. It must be repaired by the manufacturer or its service agent in order to avoid a hazard.
26. If the supply cord is damaged, it must be replaced by the manufacturer or its service agent in order to avoid a hazard.
27. The plug must be removed from the receptacle before cleaning or maintaining the Appliance. Do not unplug the Power Adapter by pulling on the power cord.

28. The Safety Battery must be replaced by the manufacturer or its service agent in order to avoid a hazard.
29. The Safety Battery must be removed and discarded according to local laws and regulations before disposal of the Appliance.
30. The Appliance must be disconnected from the receptacle before removing the battery for disposal of the Appliance.
31. Please dispose of used batteries according to local laws and regulations.
32. Do not incinerate the Appliance even if it is severely damaged. The battery can explode in a fire.
33. The Appliance must be used in accordance with the directions in this Instruction Manual. The company cannot be held liable or responsible for any damages or injuries caused by improper use.
- 34. WARNING:** For the purposes of recharging the battery, only use the detachable supply unit GM95-240375-D provided with this Appliance.
35. The robot contains batteries that are only replaceable by skilled persons.
36. The plug and the Power Adapter must be used indoor.
37. If the insulated glass, which WINBOT is working on, is leaking, remove WINBOT immediately after cleaning is completed.
38. Before cleaning, please observe the area to attach WINBOT for any small particles. If there are any, please remove them or switch to a particle-free area to avoid scratching the glass.
39. Clean the Wiping Pad in time and make sure that any small particles on it are completely removed to avoid scratching the glass.
40. The appliance is only to be used with the unit provided.
41. Keep the appliance out of reach of children when it is energized or cooling down.
42. The appliance has to be unplugged after use and before carrying out user maintenance on the appliance.
43. To reduce the risk of injury, close supervision is necessary when an appliance is used near children.
44. Do not contact moving parts.

To satisfy RF exposure requirements, a separation distance of 20 cm or more should be maintained between this device and persons during device operation.

To ensure compliance, operations at closer than this distance is not recommended. The antenna used for this transmitter must not be co-located in conjunction with any other antenna or transmitter.

	Class II
	Short-circuit-proof safety isolating transformer
	Switch mode power supply
	For indoor use only
	Direct current
	Alternating current

For EU Countries

For EU Declaration of Conformity information, visit <https://www.ecovacs.com/global/compliance>



Correct Disposal of this Product

This marking indicates that this product should not be disposed of with other household waste throughout the EU. To prevent possible harm to the environment or human health from uncontrolled waste disposal, recycle it responsibly to promote the sustainable reuse of material resources. To recycle your used device, please use the return and collection systems or contact the retailer where the product was purchased. They can safely recycle this product.

1. Product Contents

1.1 Package Contents

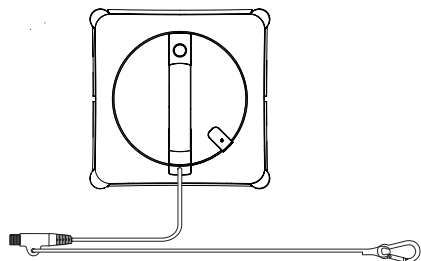

WINBOT + compound cable

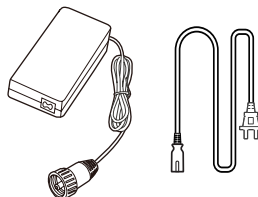

Power Adapter

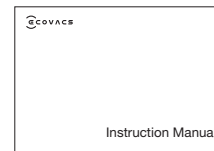

Instruction Manual



ECOVACS WINBOT Cleaning Solution

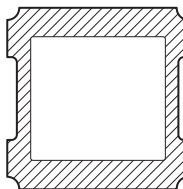

Wiping Pad

* Figures in this manual are for reference only and may differ from the appliance. Product design and specifications are subject to changes without notice.

1.2 Product Diagram

Front View

Status Indicator Light/ START Button

Filling Opening

Spray Nozzle

Bumper

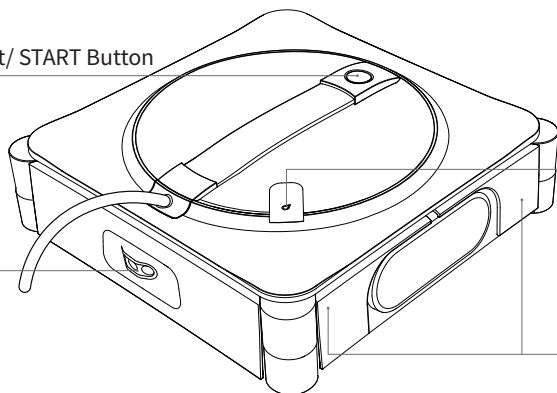

Bottom View

Driving Wheel Tracks

RESET Button

Self-Cleaning Brush

Suction Sensor

Side Rollers

Bottom Status Indicator Light

Fan

Spherical Sensors

Driving Wheel Tracks

Self-Cleaning Brush

Liquid Level Indicator

TruEdge Scrubber

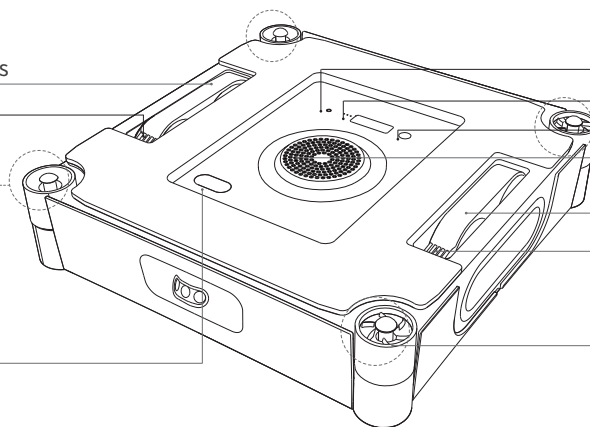

2. Quick Start

2.1 Notes Before Cleaning

The following situations are not recommended for using WINBOT:

- 1 Do not use WINBOT on windows with condensation or oil stains or in extremely cold or hot environments.

WINBOT may have difficulty moving in the following conditions.

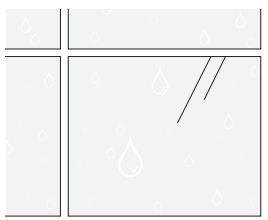

Condensation

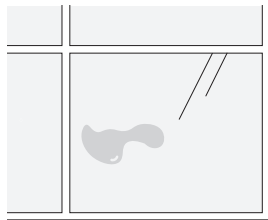

Oil stains

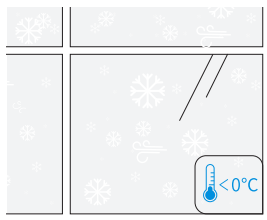

Below 0°C

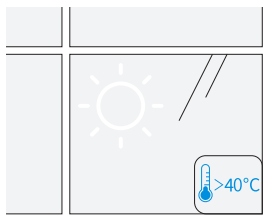

Above 40°C

 WINBOT delivers optimal performance on dry surfaces and in temperatures above 0°C .

- 2 Do not use WINBOT on windows that are too small or have irregular shapes.

WINBOT cannot move around in the following conditions.

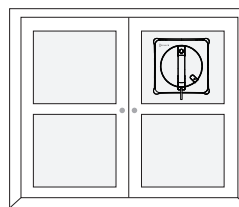

Small Glass

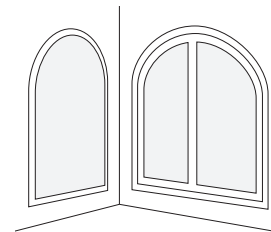

Irregular Shapes

 WINBOT delivers optimal performance on square and large windows.

3 Do not use WINBOT on uneven windows.

WINBOT may experience insufficient air pressure in the following conditions.

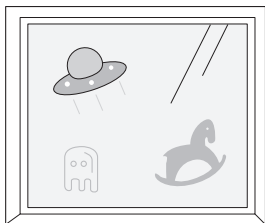

Electrostatic Window Decals, Stickers, etc.

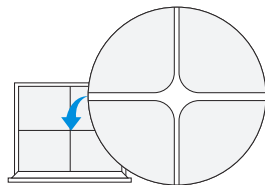

Cracks

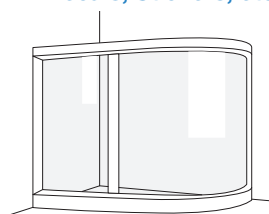

Curved Glass

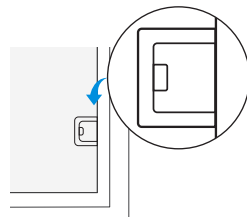

Obstacle Height < 4 mm

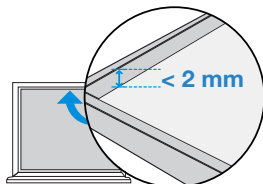

Frame Height < 2 mm

4 Do not leave the adapter suspended in the air when cleaning large glass windows.

WINBOT may fall due to prolonged suspension. Therefore, always place the adapter on the ground.

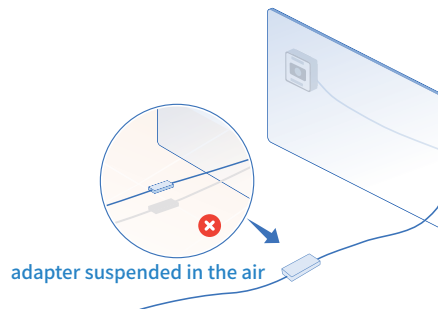

WINBOT performs better on a smooth and flat surface to ensure stable suction and smooth movement.

5 Do not use WINBOT near narrow gaps close to its height.

WINBOT may get stuck when nearby narrow spaces, openings or gaps between window handles/door handles/ curtain boxes/ cabinets and surfaces such as walls/windows, are close to its height.

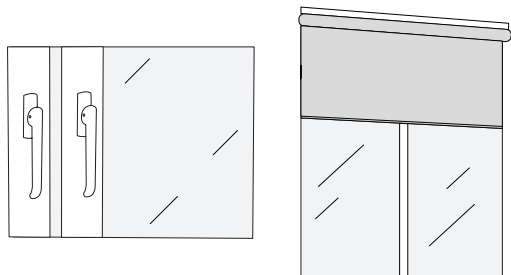

To clean glass panel doors, open the door before attaching WINBOT to avoid WINBOT falling due to narrow door gaps.

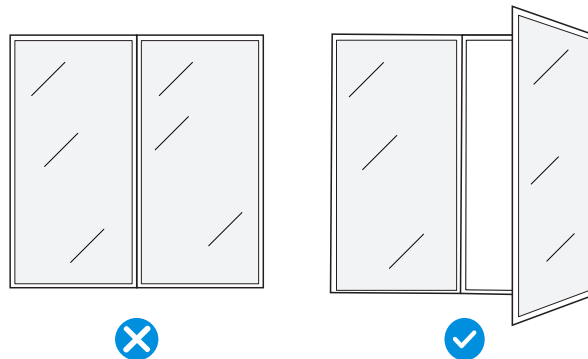

 Try placing WINBOT between the gap to confirm safe passage; if it's stuck, refrain from using the robot there to prevent damage to either itself or surrounding furniture.

Note:
Please remove all protective materials, including but not limited to the EPE protective strips wrapping WINBOT and the protective films on WINBOT's sides.

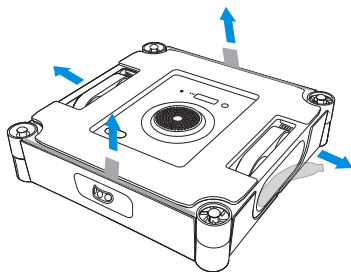

The safety rope and its carabiner are pre-installed at the factory. Do not disassemble it at will.

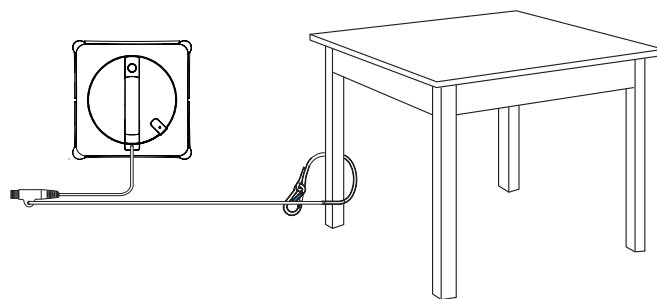

2.2 Network Connection

Download the ECOVACS HOME App to control your WINBOT and unlock more features.

a. Multiple Cleaning Modes

Thorough Cleaning: Denser cleaning path for tackling heavy dust.

Deep Cleaning: Intensive cleaning for a spotless finish.

Fast Cleaning: Quick removal of light dust.

Edge Cleaning: Cleaning along edges to clear accumulated dust.

Zone Cleaning: Leftward & Rightward—flexible division for targeted cleaning.

Spot Cleaning: Repeated wiping to remove localized dust.

Heavy-Duty Cleaning: Segmented wiping for enhanced efficiency.

b. Manual Control & Corner Return

In the APP, switching views between interior and exterior windows is supported. Manual remote control helps remove stubborn stains. The "Return to Corner" function instantly sends the robot back to a specified corner.

c. Automatic & Manual Spraying

WINBOT sprays water automatically by default for better cleaning results. Manual water spraying is also available via remote control.

d. Accessories Replacement Alerts for Better Cleaning Experience

1. Scan the QR Code on the bottom to download the ECOVACS HOME App, or search and download the APP in the APP store.

2. When installation is completed, complete registration, login, and network connection according to the guidance in the App.

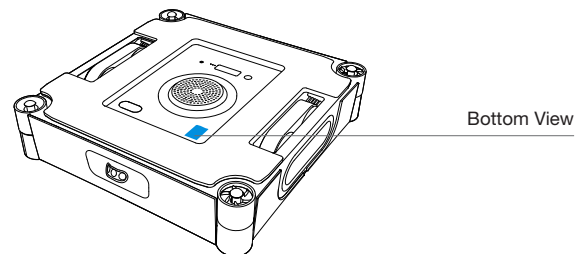

Or

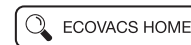

3 Install Wiping Pad

1. Wet the wiping pad

Before using, wet the wiping pad.

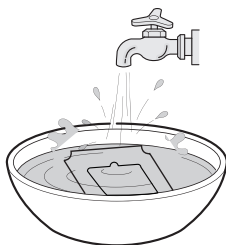

2. Twist the wiping pad

Twist the wiping pad to wring water out. To ensure cleaning performance, wring it out as much as you can.

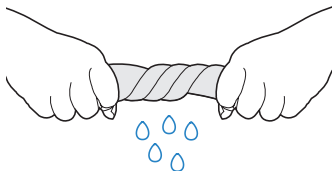

3. Stick the wiping pad

Stick the wiping pad onto the velcro on the bottom of WINBOT, ensuring the narrow and wide sides are aligned correctly. Then press firmly to secure the pad in place.

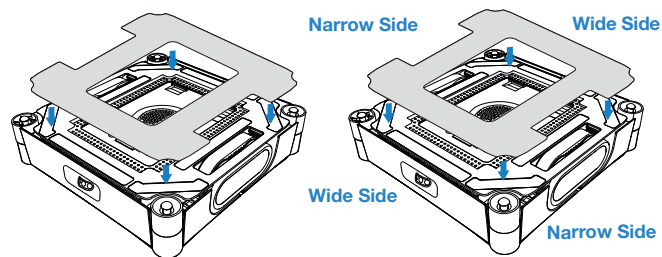

4 Tie the Safety Rope

Properly tie the safety rope to a stable object that cannot be easily moved (e.g. table leg, chair leg, bed leg, sofa leg, curtain rod, stair handrail, etc.), and lock the carabiner as shown below.

Note: Please make sure to use under supervision.

People or animals are prohibited from standing directly under WINBOT working area. Make sure there are no valuable or fragile objects under this area.

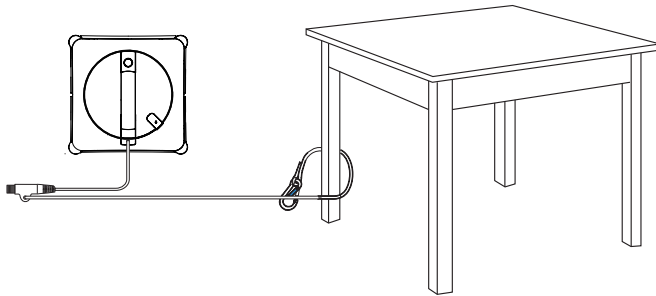

To ensure safety, please make sure to secure the carabiner before use.

* It is recommended to fasten the safety rope with the carabiner on a firm and safe metal railing.

2.4 Start Cleaning

1 Start

1. Before cleaning, ensure a clean area larger than WINBOT's size, then attach to windows.
2. Connect the power supply and long press the WINBOT start button for 2 seconds.
3. After hearing the fan start, place the bottom of the WINBOT (the side with the wiping pad) on the glass. WINBOT will adhere to the window automatically and start cleaning.

- * Do not stick the WINBOT too close to the edge when cleaning the frameless glass. It is recommended to be more than 10cm away from the edge.
- * WINBOT can only clean flat surfaces. Please make sure that the glass thickness is not less than 3mm.
- * After powering on, keep the fan away from hair and small objects to prevent blockages.
- * Regularly clean the wiping pad and remove any small particles on the pad to avoid scratching the glass.
- * Do not stand below or near the WINBOT while it is cleaning.

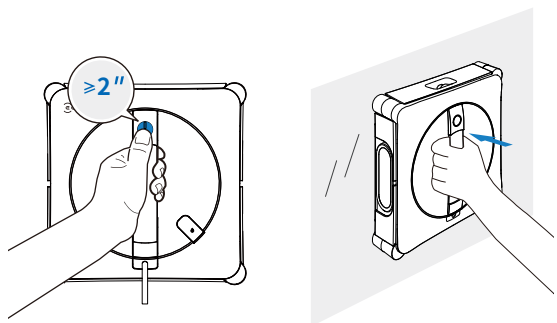

2.5 Finish

Pause

During cleaning, press  on WINBOT or pause it via App.

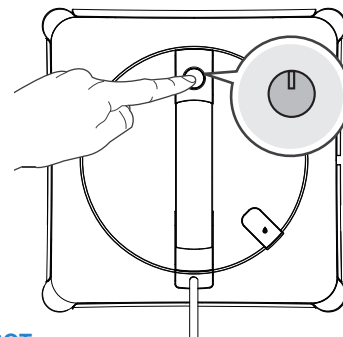

Remove WINBOT

When cleaning is complete, WINBOT will return to the starting position and beep. Please hold the handle tightly, then press and hold  for 2 seconds until the fan stops before removing WINBOT.

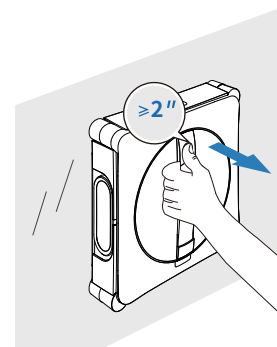

Unfasten Safety Rope

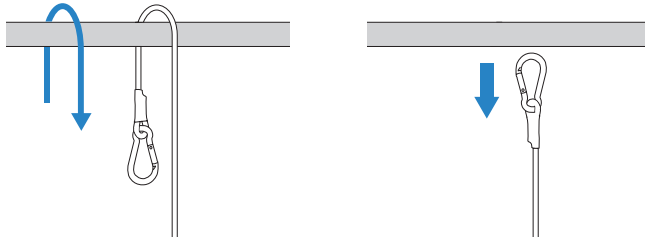

Power Off

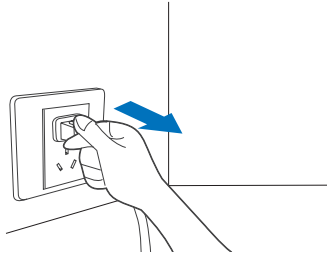

2.6 Maintenance during Cleaning

1. Ensure WINBOT's fan is not activated.
2. Place WINBOT on the wiping pad, ensuring both scrubbers fully contact the pad.

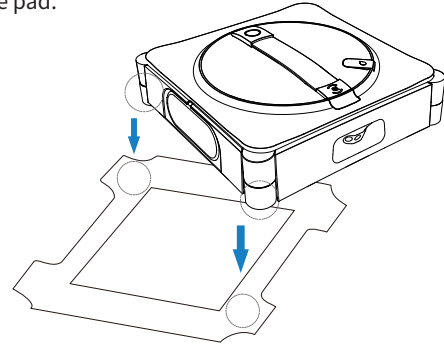

3. Press the bumpers simultaneously on both sides near the scrubbers. Release them when you hear the voice prompt "I'm starting to clean the scrubber."

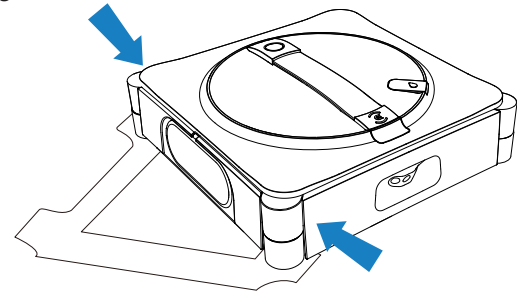

4. The voice prompt "The scrubber has been cleaned successfully" indicates that the cleaning process is finished.

3.Component Maintenance

Water Tank

Cleaning the Water Tank

After WINBOT completes cleaning, empty the remaining cleaning solution from the water tank.

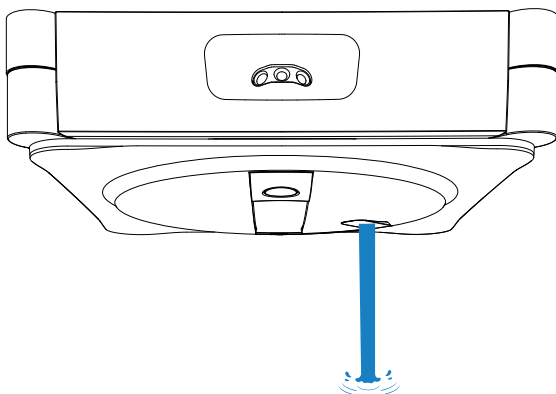

Wiping Pad

a. Replace Wiping Pad

Remove the dirty wiping pad and attach a new one flatly within the wiping pad holder at the bottom of WINBOT. Press and smooth the pad down to ensure a secure fit. Make sure the wide and narrow sides of the wiping pad align with those of the holder.

* Be careful not to stick the wiping pad outside the holder to avoid affecting WINBOT's operation.

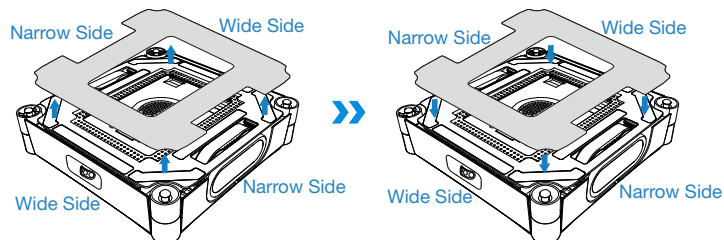

* If the velcro on the wiping pad holder is dusty, use a cleaning brush to remove the dust. Do not wash with water to prevent water from entering the bottom of the robot, which may cause damage.

b. Wash Wiping Pad

Remove the wiping pad. Wash it with tap water, and wring it as dry as possible before use.

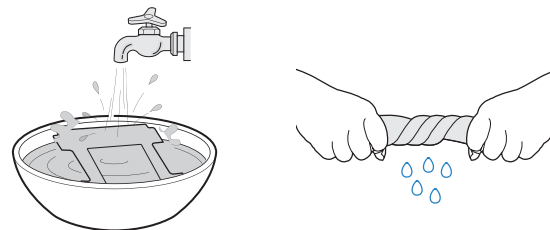

* Regularly clean the wiping pad to extend its service life. If the wiping pad becomes worn or no longer adheres securely to the velcro, replace it with a new one to achieve optimal cleaning performance.

Explore more accessories at the ECOVACS HOME App or at <https://www.ecovacs.com/global>.

Driving Wheel Tracks

Before cleaning, ensure the fan is not running. Use the ECOVACS HOME App to remotely control WINBOT and check the driving wheel tracks. Pause the driving wheel tracks' operation if dirt is found. Then wipe the tracks clean with a clean cloth.

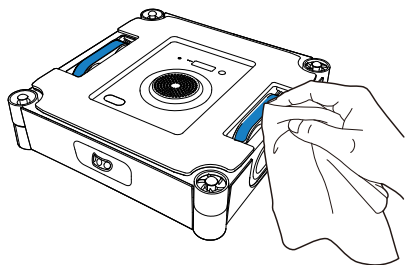

After cleaning the driving wheel tracks, install the wiping pad and resume cleaning tasks.

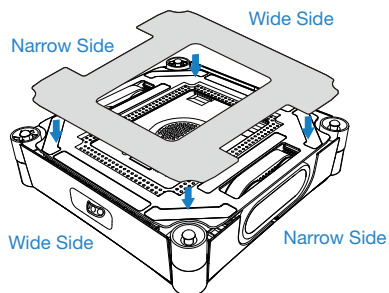

Bottom Component

Fan: Wipe clean with a dry cloth to prevent damage to WINBOT's suction force.

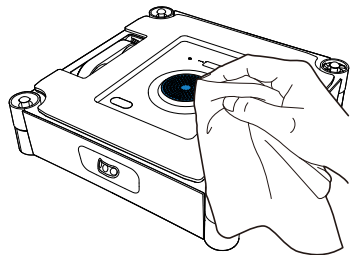

Spherical Sensors: Wipe clean with a dry cloth to maintain its sensitivity.

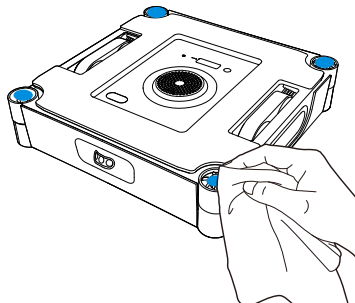

Side Rollers: Wipe clean with a dry cloth to maintain its sensitivity.

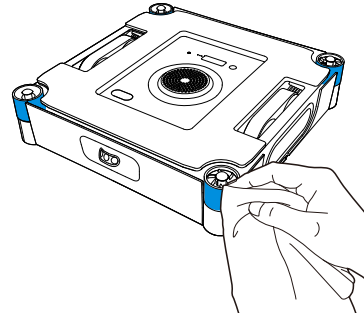

* After WINBOT issues a low battery warning, ensure WINBOT is fully charged before using or storing it to avoid reducing battery service life.

* If WINBOT will not be used for an extended period, fully charge it, turn it off, and store it properly. To prevent battery damage and charging failure due to over-discharge, recharge it at least once every six months.

4. Status Indicator Light

Indicator	Light Effect	Meaning
START button/ Bottom Status Indicator Light	Solid Blue	WINBOT is working properly.
	Flashing Red	Malfunction. WINBOT is unable to function properly.
Adapter Status Indicator Light	Solid Green	WINBOT consumes a low current, for instance, in the standby mode.
	Solid Red	WINBOT consumes a high current, for instance, in the charging mode.

5. Troubleshooting

5.1 Issue Resolution

No.	Issues	Possible Causes	Solutions
1	WINBOT slips, such as sliding sideways or body shaking.	The wiping pad is too wet.	Refer to [Component Maintenance] in this manual to replace the wiping pad.
		WINBOT wipes non-recommended stains, such as oil stains.	Refer to [Component Maintenance] in this manual to clean the driving wheel tracks.
2	WINBOT voice prompts "Insufficient air pressure".	The wiping pad is not attached properly.	Remove the wiping pad and reattach. Make sure the wide and narrow sides of the wiping pad align with those of the holder.
		There are gaps or cracks on the window.	Do not use WINBOT on surfaces with gaps.
		There are low obstacles on the window surface.	Manually cover the obstacles before using WINBOT.

3	WINBOT voice prompts "Stuck".	The driving wheel tracks are stuck.	Check if there is any dust or debris on the driving wheel tracks. If so, clean them with tools. Then restart WINBOT for auto cleaning. If the problem persists, please contact customer service.
		There are low obstacles on the window surface.	WINBOT cannot detect obstacles or frames with a height lower than 4 mm. In this case, please go to the App and follow the instructions to help WINBOT out.
4	WINBOT voice prompts "Stuck".	There is no cleaning solution in the water tank.	Please add ECOVACS WINBOT cleaning solution in time.
		The auto-spraying function is turned off in the App.	Please go to the App and turn on the auto-spraying function.
		WINBOT is cleaning at a low water level.	<ol style="list-style-type: none"> 1. Turn off WINBOT, restart it, and reattach it. 2. Visit the App and follow the auto-spraying precautions to solve the problem. 3. If the problem persists, please contact customer service.
5	WINBOT voice prompts "WINBOT encounters an obstacle".	The internal components are abnormal.	Firmly hold the compound cable and do not stand directly below WINBOT to prevent being injured by the falling WINBOT. Slowly drag WINBOT until it can be reached. Press and hold the START button for 2 seconds, and then remove WINBOT. Turn off WINBOT, disconnect the power, and then restart it. If the issue persists after restarting, please contact customer service.

6	WINBOT has not returned to its origin and cannot be removed.	There is an error in the algorithm.	Affected by the calculation accuracy, there may be a slight error. The normal error is less than 21 cm. If the error of WINBOT returning to the origin is too large and it is inconvenient to retrieve WINBOT, please go to the App and remotely control WINBOT to return to a position that is easy to remove it.
		The remote control function was used after WINBOT was adhered to, so WINBOT does not know the original position.	Go to the App and use remote control to help WINBOT return to a position that is easy to remove.
7	WINBOT voice prompts "Please avoid the window corners."	When cleaning frameless glass, the adhering position of WINBOT is too close to the window frame.	Hold WINBOT's handle, press and hold WINBOT's START button for 2 seconds, and then remove and reattach WINBOT. It is recommended that the adhering position be more than 10 cm away from the window corners.

5.2 Connect WINBOT with APP

When connecting the robot via Bluetooth in the ECOVACS HOME App, please ensure the following conditions are met for both the robot and your phone:

1. Bluetooth on your phone is turned on.
 2. The station is powered on, and the indicator light is on.
 3. Pair WINBOT via Bluetooth in the ECOVACS HOME App; avoid pairing through your phone's Bluetooth settings.
 4. Bluetooth and Wi-Fi may interfere with each other during pairing. For optimal connection, keep WINBOT close to the phone and away from the Wi-Fi router.
 5. If WINBOT fails to connect to the App, try disconnecting other connected Bluetooth devices, ensure WINBOT is not paired with another phone, and then try again.
 6. When using remote control, Bluetooth may disconnect if the phone is too far away or if there are walls in between. If disconnected, try reconnecting at a closer distance.
 7. When using WINBOT, allow the ECOVACS HOME App to access location, Bluetooth, and phone storage permissions.
- Please contact customer service if the above methods fail to help connect.

6. Technical Specifications

WINBOT Model	WG891-12	Power Adapter Model	GM95-240375-D
Rated Input	24V === 3.75 A	Input:	100-240V~ 50-60Hz 2.5 A
Rated Power	90 W	Output:	24V === 3.75 A
WINBOT dimensions (L x W x H mm)	271*271*77		
Off/Standby Mode Power	Less than 0.50 W		
Frequency Bands	2400-2483.5 MHz		

The max.EIRP of the window cleaning robot is 1.357dBm.

Note: Technical and design specifications may be changed for continues product improvement.

Access Complete Instruction Manual

Scan the QR code on the robot to access the full instruction manual.

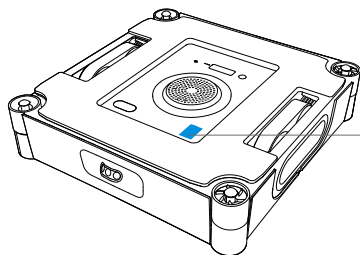

Bottom View